

Defense Personal Property Program International Tender – 2024

Change 1



Personal Property Publication

**Rules Governing the International Movement of
Personal Property for Department of Defense and the Coast Guard**

Managed By:

**United States Transportation Command
Defense Personal Property Management Office (DPMO)
508 Scott Drive
Scott AFB, IL 62225**

Effective 15 May 2024 through 14 May 2025

Table of Contents

List of Changes	9
Acronyms	11
Definitions	13
Introduction	19
Purpose	19
Authority	19
DoD Approved TSP and TSP Representation	19
Safeguarding Personally Identifiable Information (PII)	19
Presidential Executive Orders	20
Altering Government Documents	20
Application and Scope	20
Pass Through Requirements	23
TSP Correspondence	23
Chapter 1: Regionalization	24
Chapter 2: Policy and Procedures	25
Item 200 - Application of Tender	25
Item 201 - Minimum Weight	26
Item 202 - Determination of Weight	26
Item 203 - Governing Regulations	28
Item 204 - Designation of Overseas Theater Command Areas	29
Item 205 - Reserved for Future Use	29
Item 206 - Holidays	29
Item 207 - Hourly Rates	30
Item 208 - Advanced Charges	30
Item 209 - Reserved for Future Use	30
Item 210 - Impractical Operations	30
Item 211 - 212 - Reserved for Future Use	31
Item 213 - Removal or Placement of Property From or To Inaccessible Locations	31
Item 214 - 219 Reserved for Future Use	31
Item 220 - Performance and Data Periods	31
Item 221 - Use of Foreign Flag Shipping	32
HHG Foreign Flag Waiver Request Form	36
Statement of Non-Availability of U.S. Flag Air Carriers	38

Item 222 - Air Clearance Authorities	39
Item 223 - Customs/Agricultural Inspection Charge - HHG	39
Item 224 - Customs/ Agricultural Inspection Charge - UB	40
Item 225 - 226 Reserved for Future Use.....	40
Item 227 - Pickup at or Delivery to a Military Terminal	40
Item 228 - General Average/Salvage.....	40
Item 229 - DoD Peacetime and Contingency (VISA) Sealift Requirements	40
Item 230 - Release of Cost Data.....	41
Item 231 - Surcharge.....	41
Item 232 - TSP Representation	43
Item 233 - Emergency Services.....	43
Chapter 3 - Conditions, Rules, and TSP Administration Requirements	45
Purpose.....	45
Item 300 - Rate Filing Prerequisites.....	45
Item 301 - Reserved for Future Use	45
Item 302 - Criteria for Eligibility as Small Disadvantaged Business Concern for the Purpose of Transportation Service Acquisition	45
Item 303 - Reserved for Future Use	45
Item 304 - Compensatory Rates.....	45
Item 305 - 308 Reserved for Future Use.....	46
Item 309 - Intra-European Theater Rates	46
Item 310 - 311 Reserved for Future Use.....	46
Item 312 - Inter-Theater Code J and T Shipments.....	46
Item 313 - 316 Reserved for Future Use.....	46
Item 317 - Reporting Requirements.....	46
Item 318 - Reserved for Future Use	47
Item 319 - Delivery to Storage In Government Facilities	47
Item 320 - TSP Agent/Port Agent Facilities.....	48
Item 321 - Right to Audit by DoD	49
Item 322 - Right to Audit by Comptroller General	49
Item 323 - Intra-Theater Tenders.....	50
Item 324 - Required Numbers	50
Item 325 - Shipment Terminations.....	50
Item 326 - Excess Cost	51
Item 327 - 329 Reserved for Future Use.....	51

Item 330 - Intra-Theater Pacific Rates	51
Item 331 - 332 Reserved for Future Use.....	52
Item 333 – Packing Privately Owned Firearms (POFs).....	52
Item 334 - 335 Reserved for Future Use.....	52
Chapter 4 - Claims and Liability	53
Purpose.....	53
Item 400 - Claims	53
Item 401 - Reserved for Future Use	53
Item 402 - Collection of Freight Charges on HHG Shipments Involving Loss or Destruction in Transit and on Shipments Transported.....	53
Chapter 5 - Schedule of Rates and Charges.....	54
Purpose.....	54
General Requirements and Conditions	54
General Price Adjustment (GPA).....	54
Item 500 - Additional Services	55
State GBLOC Item 500 Table.....	56
Item 501 - Shuttle Services (Auxiliary Service)	66
Item 502 - Labor Charges.....	68
Item 503 - Waiting Time	69
Item 504 - Overtime Loading and Unloading.....	71
Item 505 - Reweighing.....	71
Reweigh (HHG):.....	73
Reweigh (UB):	74
Item 506 - Debris Removal - HHG ONLY	74
Item 507 - Reserved for Future Use	75
Item 508 - Crates/Special Containers	75
Item 509 - Extra Pickup or Delivery	78
Item 510 - Attempted Delivery to Residence from SIT	79
Item 511 - 512 - Reserved for Future Use	81
Item 513 - Fuel Surcharge (CONUS, Including Alaska, and Hawaii).....	81
Item 514 - Government-Owned Containers (GOCs)	83
Item 515 - Reserved for Future Use	84
Item 516 - Shipping Procedures for the Hawaiian Islands.....	84
Item 517 - Shipping Procedures for the Florida Keys.....	84
Item 518 - SIT and Warehouse Handling Charges - HHG.....	84

SIT and Warehouse Handling Charges by Location - HHG	89
Item 519 - SIT and Warehouse Handling Charges - UB	90
SIT and Warehouse Handling Charges by Location - UB.....	91
Item 520 - Pickup or Delivery Transportation Rates to Apply on SIT Shipments – HHG	91
Pickup or Delivery Transportation Rate Schedules:	94
Item 521 - Pickup or Delivery Transportation Rates to Apply on SIT Shipments - UB	99
Item 522 - Termination of Shipments - HHG	101
Item 523 - Termination of Shipments - UB.....	103
Item 524 - Reshipments - HHG	105
Item 525 - Reshipments - UB	106
Item 526 - Shipments Diverted After Commencement of Transportation Service.....	107
Item 527 - Delivery of Split Code T Shipments	108
Item 528 - Use of Alternate Ports for Code T Shipments	109
Item 529 – Use of Alternate Ports for Code J Shipments.....	111
Item 530 - Linehaul Rate Schedules.....	113
Item 531 – Reserved for Future Use.....	135
Item 532 - Excessive Distance Carry Charges To/From Residence or Mini-Storage Warehouse.....	135
Item 533 - Miscellaneous Charge	135
Item 534 - Third Party Service Charge.....	136
Chapter 6 - Billing and Payment.....	138
Purpose.....	138
Item 600 - Billing and Payment Requirements.....	138
Item 601 - Billing Instructions.....	138
Chapter 7 - One-Time-Only Procedures for INTL HHG, UB, and Boat Shipments.....	139
Purpose.....	139
Item 700 - Criteria for Use of OTO Rates.....	139
Item 701 - Procedures	140
Item 702 - Mistake in Rate Filing	143
Item 703 - Rate Revision Requests	143
Item 704 - TSP iOTO/iBOTO Qualifications and Quality Assurance	145
Chapter 8 - Solicitation for Frustrated Shipments	147
Purpose.....	147
Item 800 - Ports.....	147
Item 801 - Rates - HHG	147

Item 802 - Rates - UB.....	147
Item 803 - Awards	148
Item 804 - Payment Responsibility	148
Item 805 - Return of TSP Equipment.....	148
Item 806 - Reporting Operational Problems.....	148
Item 807 - Standards	148
Item 808 - Announcement for Bids	148
Item 809 - Submission of Bids	149
Chapter 9 - Volume Moves Procedures	150
Purpose.....	150
Item 900 - Criteria for Use of Volume Move Rates.....	150
Item 901 - VM Procedures.....	150
Item 902 - Reserved for Future Use	151
Item 903 - Submission of Rates and Charges.....	151
Item 904 - Receipt of Submission	153
Item 905 - Reserved for Future Use	153
Item 906 - Terms and Conditions for Individual Rate Bid Submission.....	153
Item 907 - Effective Period for Accepted Bid Submissions.....	153
Item 908 - Administrative Action	153
Item 909 - Correction to Volume Movement Individual Rate Tenders	154
Item 910 - Acceptance/Rejection of Individual Rate Submission.....	154
Item 911 - Volume Move Rates - Public File	154
Item 912 - Selecting Number One TSP for VM	155
Item 913 - Volume Move Shipment Distribution	155
Item 914 - Volume Move Blackout Status	155
Item 915 - Additional Guidance	155
Chapter 10 - Special Solicitation	157
Purpose.....	157
Item 1000 - Standards	157
Item 1001 - Estimated Traffic/Shipments	158
Item 1002 - Reserved for Future Use	158
Item 1003 - General.....	158
Item 1004 - Participation and Performance.....	159
Item 1005 - State Department Agents for OCONUS SS Rate Areas.....	160
Chapter 11 - Code J Unaccompanied Baggage	161

Purpose.....	161
Item 1100 - Reserved for Future Use	161
Item 1101 - Terms and Conditions.....	161
Item 1102 - 1104 Reserved for Future Use.....	161
Item 1105 - Movement from CONUS to Overseas.....	161
Item 1106 - Movement from Overseas to CONUS.....	162
Item 1107 - Tracing Procedures	162
Chapter 12 - Department of State Arranged Moves	163
Purpose.....	163
Item 1200 - Participation.....	163
Item 1201 - Procedures	163
Chapter 13 - Rate Areas and Maps.....	165
Purpose.....	165
Item 1300 - Reserved for Future Use	165
Item 1301 - Special Rate Information - CONUS.....	165
Item 1302 - Special Rate Information - OCONUS.....	165
Item 1303 - Maps of States and Countries Divided into Separate Rate Areas	169
California.....	169
Florida.....	170
Florida: US49, US4964400 and US4965500 Counties.....	171
Texas.....	172
Texas: Counties.....	173
Alaska.....	174
Alaska: Cities.....	175
Alaska: Cities (Zone IV - OTO US8142800).....	176
Australia.....	177
Canada	178
Japan.....	179
Chapter 14 - Aerial and Surface Ports.....	181
Purpose.....	181
Item 1400 - 1402 Reserved for Future Use.....	181
Item 1403 - Alternate Ports.....	181
Item 1404 - 1406 Reserved for Future Use.....	181
Item 1407 - Code J Port Designation.....	181
Item 1408 - Overseas AMC Terminals for Code J Shipments.....	182

Item 1409 - Code T Port Designation	183
Item 1410 - Overseas AMC Terminals for Code T Shipments	184
Item 1411 - 1412 Reserved for Future Use.....	185
Item 1413 - Code 4 Ports of Embarkation and Debarkation	185
Chapter 15 - Rate Areas and SPLC Codes	186
Purpose.....	186
Item 1500 - Rate Areas & SPLC Codes.....	186
Item 1501 - CONUS Rate Areas, SPLC Codes & Abbreviations.....	186
Item 1502 - Overseas Rate Areas & SPLC Codes.....	187
Item 1503 - Intra-Country Move Rate Areas	187
Chapter 16 - Historical Shipment Data and Channel Control Listing.....	189
Purpose.....	189
Item 1600 - Historical Shipment Data	189
Item 1601 - Traffic Awards.....	189
Item 1602 - Channel Control.....	189
Item 1603 - Web Links.....	189
Attachments.....	190
Figure 1. Certification of Independent Pricing.....	190
Figure 2. Nondisclosure Agreement.....	191
Figure 2. Nondisclosure Agreement (Cont'd)	192

Version Number	Description	Revision Date	Page Numbers
	- Item 521: Updated pre-approval mileage to 100 miles		91-92 99-100
IT-22 Change 3	- Item 505: Updated reweigh language - Item 513: Clarified fuel surcharge billing language	18 Oct 22	73-74 81-82
IT-22 Change 4	- Item 513: Removed Item Code references from para 7.a.	11 Jan 23	82
IT-23	- Grammatical changes made throughout document - Acronyms: Added additional acronyms - Item 220: Updated Data Periods for CSS - Chapter 5: Updated CONUS rates using GPA of 8.225640004% (used June CPI-U/CEU); updated OCONUS rates using worldwide inflation data - Item 502: Added verbiage regarding gun safes - Item 509: Updated example - Item 516: Updated language - Item 518: Adjusted rates for Guam (outside of GPA increase) - Item 519: Added Guam to Item 519 table - Item 520: Adjusted rates for Guam (outside of GPA increase) - Item 530: Updated example - Item 1003: Added additional Class 1 SS groups; updated language for Saudi Arabia SS groups - Item 1502: Added Israel to list of Overseas Rate Areas	04 Nov 22	11-12 30 67 78 82 87 89 95 133 156-157 185
IT-23 Change 1	- Item 1003: Added clarification for Israel	11 Jan 23	156
IT-23 Change 2	- Throughout changed punitive action to administrative action - Item 207: Clarified language - Item 326: Correction to General Services Administration - Item 500: Updated Ft. Bragg to Ft. Liberty (effective 2 June 23) - Item 500: Updated Ft. Hood to Ft. Cavazos (effective 9 May 23) - Item 502: Clarified language - Item 503: Removed "vehicle" from para 3 a. and clarified reference to hours in para 6. - Item 518: Removed 1-day storage language and provided reference to the Tender of Service for additional information - Item 526: Removed 30-mile references - Item 700: Updated language and provided clarification - Item 701: Updated language and provided clarification - Item 703: Updated language, provided clarification, and removed 30-mile references - Item 1303 (Texas): Updated Ft. Hood to Ft. Cavazos (effective 9 May 23) - Item 1303 (Alaska): Clarified Alaska information	13 Sep 23	29 50 61 63 67 69 83 106 137 139-141 141-143 170 172-174
IT-24	- Chapter 5: Updated CONUS rates using GPA of 5.437930480% (used June CPI-U/CEU); updated OCONUS rates using worldwide inflation data - Item 513: Changed the FSC Baseline from \$2.50 to \$3.50	28 Dec 23	various 80
IT-24 Change 1	- Added: Fuel Related Rate Adjustment Language and chart.	5 Mar 24	11, 14, 82

Acronyms

<u>Acronym</u>	<u>Description</u>
BL	Bill of Lading
BSC	Bunker Surcharge
CEU	Current Employment/Unemployment Index
CFR	Code of Federal Regulations
CONUS	Continental United States
COS	Code of Service
CPI	Consumer Price Index
CU FT	Cubic Foot/Feet
cwt	Hundredweight (TWT / 100)
DoD	Department of Defense
DPS	Defense Personal Property System
DTOD	Defense Table of Official Distances
DTR	Defense Transportation Regulation
FRA	Fuel Related Rate Adjustment
FSC	Fuel Surcharge
GBD	Government Business Day(s)
GPA	General Price Adjustment(s)
GSA	General Services Administration
HHG	Household Goods
ITO	Installation Transportation Officer
JPPSO	Joint Personal Property Shipping Office
L/C	Long Carry
LHS	Linehaul Charge
NADA	National Automobile Dealers Association
NTS	Non-Temporary Storage
NTSR	Non-Temporary Storage Release
OBL	Ocean Bill of Lading
OCONUS	Outside the Continental United States
OT	Overtime
OTO	One-Time-Only
PACK/UNPACK	Packing or Unpacking
PBP&E	Professional Books Paper and Equipment
P/D	Pickup or Delivery
PEO	Presidential Executive Order
PPPO	Personal Property Processing Office
PPSO	Personal Property Shipping Office
RDD	Required Delivery Date
SCAC	Standard Carrier Alpha Code
SDDC	Military Surface Deployment and Distribution Command
SIT	Storage-in-Transit
SMO	Storage Management Office

<u>Acronym</u>	<u>Description</u>
SPLC	Standard Point Location Code
SS	Special Solicitation
TCMD	Transportation Control Movement Document
TO	Transportation Officer; Transportation Office
TPPS	Third Party Payment System
TRB	Transportation Review Board
TSP	Transportation Service Provider
UB	Unaccompanied Baggage
USTRANSCOM	United States Transportation Command
W/H	Warehouse Handling

Definitions

Air Mobility Command (AMC): The single DoD operating agency responsible for providing DoD airlift services.

Bill of Lading (BL): An accountable shipping document used for the acquisition of authorized transportation and related services from commercial Transportation Service Providers (TSP) for the movement of DoD-sponsored personal property shipments.

Channel Control Listing (CCL): A listing stipulating open and closed rate fields, by codes of service, for each origin/destination combination whereby rates are filed between CONUS and overseas rate areas, inter-theater, intra-theater movements, and intra-country moves.

Codes of Service (COS):

Code 4: International Door-to-Door Container: Movement of HHGs in containers whereby a TSP provides complete through service from origin residence to the destination residence over land and/or ocean means.

1. Code 4 for intra-country moves channels is defined as movement of HHGs in a motor van or container from origin residence to destination residence within OCONUS intra-country channels. The actual mode of service is at the discretion of the TSP, however, if the TSP chooses to containerize it will be at no additional cost to the shipper/Government.
2. Approved use of Portable Moving Storage Containers (PMSC) for Code 4 European intra-theater moves not moving over the water/ocean for any portion of movement as follows:
 - a. Intra-theater shipments.
 - b. Intra-country moves.
 - c. Intra-theater one-time-only moves.
3. Examples where PMSCs are prohibited would include:
 - a. mainland Italy to/from Sicily,
 - b. Belgium to UK using ferry, etc.,
 - c. All other Code 4 movements of DoD household goods using PMSCs outside of CONUS.

Code 6: International Door-to-Door Air Container: Movement of HHGs whereby the TSP provides containerization at the origin residence, surface transportation to the airport nearest origin that can provide required services, air transportation to the airport nearest destination that can provide required services, and transportation to the destination residence.

Code 7: International Land-Water-Land Baggage: Movement of UB whereby the TSP provides packing and pickup at origin, surface transportation to destination, and cutting of the banding and opening of the box(s) when delivered at the destination residence.

Code 8: International Land-Air-Land Baggage: Movement of UB whereby a TSP provides packing and pickup at origin, transportation to the origin airport, air transportation to the destination airport, surface transportation to destination, and cutting the banding and opening of the box(s) at the destination residence.

Code J: Land-Air (AMC)-Land Baggage: Movement of UB whereby a TSP provides packing and pickup at origin, and transportation to the designated AMC aerial port or receipt of property from the Theater Shipping and Consolidation Point (TSCP) to final delivery point. AMC provides terminal services at both origin and destination and air transportation to the designated AMC destination terminal. The TSP provides transportation to destination from AMC terminal and cutting of the banding and opening of the box(es) at the destination residence.

Code T: International Door-to-Door Container (AMC): Movement of HHGs in containers whereby a TSP provides containerization at the origin residence and transportation to the designated AMC terminal. AMC provides terminal services at both origin and destination and air transportation to the designated AMC destination terminal. The TSP provides transportation to the destination residence.

Continental United States (CONUS): As used in connection with HHGs, it includes all areas within the United States, excluding Hawaii. For purposes of soliciting rates for UB, it includes all areas within the contiguous United States, excluding Alaska and Hawaii.

Demurrage: A charge payable to the owner of a chartered ship in respect of failure to load or discharge the ship within the time agreed.

Destination Point: City or installation shown in the destination block on the Bill of Lading.

Diversions: A change in the original destination of a personal property shipment while the shipment is in transit or located at a POE/POD. Shipments requiring further over ocean transportation shall be terminated and reshipped.

Filing Dates: Designated dates announced by USTRANSCOM during which international rates and other data must be filed.

Final Delivery Point: Place where TSP surrenders possession of property to the customer or customer's agent and no further transportation or services are required under the personal property Bill of Lading.

Fuel Related Rate Adjustment (FRA): Fuel Cost: The national average diesel fuel price is published by the U.S. Energy Information Administration (EIA). The diesel fuel prices published by the EIA may be found via the following link: <https://www.eia.gov/petroleum/gasdiesel>. U.S. On-Highway Diesel Fuel Prices

Government Bill of Lading Office Code (GBLOC): A designated code consisting of 4 alpha characters unique to each PPSO. GBLOCs are used for internal accounting purposes and for the distribution of information to PPSOs.

Government Business Day(s) (GBD): A business day (i.e., Monday through Friday) that is not a Federal Holiday.

Government Storage Warehouse: Government-owned or leased facility used for storing HHGs shipments.

Gross Weight: The aggregate weight of all articles plus necessary packing materials and shipping containers.

Household Goods (HHGS) / Personal Property (PP): Furniture, furnishings, boats, or equipment; clothing, baggage, personal effects, professional books, papers, and equipment

(PBP&E); and all other personal property associated with the home and person, as defined in the Joint Travel Regulations (JTR).

Installation Transportation Officer (ITO): The military or civilian employee of the Government, designated by the appropriate authority to perform assigned personal property traffic management functions at an installation or activity, regardless of whether or not it is the organizational title of the individual. See Personal Property Shipping Office.

Inter-Theater Movement: Movement of personal property from an origin point in one overseas theater to a destination point in another overseas theater. Movements to or from CONUS are not considered inter-theater.

Intra-Theater Movement: Movement of personal property from an origin point in an overseas theater to a destination point in the same overseas theater.

Item/Article: The terms "item" and "article" used in this Tender shall be interchangeable. Each shipping piece or package, and the contents thereof, shall constitute one item. Any item taken apart or knocked down for handling or loading shall constitute one item.

Kilogram: One kilogram (kg) is equal to 2.20462 pounds (lbs.). To convert kg into lbs., multiply kg by 2.20462 factor. To convert lbs. into kg, multiply lbs. by 0.453592 factor.

Kilometer: One kilometer is equal to 3,280.84 feet or 0.621371 mile. To convert kilometers into miles, multiply the number of kilometers by a 0.621371 factor. To convert miles into kilometers, multiply the number of miles by a 1.609 factor.

Military Sealift Command (MSC): The single DoD operating agency responsible for providing DoD sealift service.

Net Weight: The net weight of shipments transported in containers shall be the difference between the tare weight of the empty container and the gross weight of the packed container.

Non-Temporary Storage (NTS): The term applied for the service of long-term storage, other than SIT, of personal property at customer's or Government expense.

One-Time-Only (OTO) Rates: The movement of a shipment where rates are solicited by USTRANSCOM from individual TSPs for the movement of personal property over a specific origin to destination channel for which rates are not otherwise published.

Operation Cohort: Operation COHORT is another name given to U.S. Army volume movements between CONUS and overseas locations. Any special requirements such as pickup, movement on the same vessel, and delivery en masse, will be contained in the Tender.

Origin Installation: Military installation or activity with a PPSO controlling and issuing BLs for personal property shipments.

Overseas Theater: An overseas area composed of those elements of one or more of the Armed Services, designated to operate in a specific geographical area, e.g., the Pacific, European, Southern, or other command.

Packing Carton: Packing carton used for packing items requiring additional protection prior to placement inside shipping container.

Personal Property Shipping Office (PPSO): An office designated by appropriate authority to perform personal property traffic management functions for an area of responsibility. PPSO

locations may be obtained at <https://installations.militaryonesource.mil/?looking-for-a=program/program-service=2/focus=program>.

Pickup Point: The specific location where the TSP takes possession of personal property for shipment.

Point of Diversion: The location of the shipment when orders are given to change destination point.

Port of Embarkation/Debarcation:

1. Ocean (WPOE/WPOD): Includes dock, wharf, pier, or berth where cargo is loaded aboard a ship or is discharged from a ship, including the port terminal facility or warehouse of the TSP serving the port.
2. Aerial (APOE/APOD): Includes AMC facilities for loading, unloading, and handling of shipments, including the port terminal facility or warehouses of the TSP serving the port.

Rate Area: An area is generally defined as each of the states and the District of Columbia (DC) in CONUS, a country/U.S. possession, or other such description in the overseas area. However, individual states and countries may be subdivided into two or more rate areas or combined into a single larger rate area to facilitate service and rate computations.

Rate Cycle: Effective dates for DPS Rate Cycles will begin 15 May and end 14 May each year.

Regular Working Hours: Regular working hours include Monday through Friday, between the business hours of 8:00 a.m. and 5:00 p.m., excluding all other hours of the day, days of the week, and officially declared foreign national, U.S. national or state holidays, and during any hour on Good Friday when service is rendered on that day in New York City and the New York Counties of Dutchess, Erie, Genesee, Livingston, Monroe, Nassau, Niagara, Orange, Ontario, Orleans, Putnam, Suffolk, Ulster, Wayne, Westchester, and Wyoming.

Required Delivery Date (RDD): A specified calendar date on or before when the TSP agrees to offer the entire shipment of personal property for delivery to the customer or customer's agent at destination. If the RDD falls on a Saturday, Sunday, foreign national, U.S. national, or state holiday, the RDD will be the following workday.

Rate Rejection Report: A listing of rates, derived from TSP's rate submission, which is erroneous and is provided to TSPs via e-mail from DPS.

Shipping Container: External container, crate, tri-wall, bi-wall, or other Government-approved container into which individual articles and/or packing cartons are placed.

Shuttle Services: The use of labor and/or non-standard linehaul or delivery vehicles when essential to effect pickups or delivery of shipments when approved, in writing, by PPSO as the result of the origin or destination being inaccessible by virtue of building design or roadway nonexistence, design, condition, construction, or obstacles (see Item 501). A shuttle is a truck-to-truck transfer, not a truck to warehouse or warehouse to truck transfer.

Special Solicitation (SS): Rates solicited by USTRANSCOM from individual TSPs for movement of personal property between specific rate areas (see Chapter 10).

Standard Carrier Alpha Code (SCAC): A 4-digit alpha code assigned to each TSP by the National Motor Freight Traffic Association (NMFTA) to identify that TSP in the various

procedures and documents used in the Department of Defense Personal Property Shipment and Storage Program (DP3). For purposes of this Tender "Carrier" is equivalent to TSP.

Standard Point Location Code (SPLC): A standard point location code consisting of alphanumeric characters assigned to each rate area for the purpose of geographical accounting.

Storage-in-Transit (SIT): The term applied to the service under the BL for the temporary storage, other than non-temporary storage, of a personal property shipment prior to final delivery.

Subcontract: Any contract entered into by a subcontractor to furnish supplies or services for performance of a prime TSP under this Tender or a subcontract.

Subcontractor: Any supplier, distributor, vendor, or firm that furnished supplies or services to or for a prime TSP or another subcontractor.

Supporting Documentation: Documentation requiring TSP certification and submission to USTRANSCOM by designated date.

Termination of Shipment: Shipment stopped at any point after the TSP has been awarded the shipment. Such termination will not constitute a diversion. The point of termination will become the destination point and all rates and charges will be computed accordingly.

Theatre Shipping and Consolidation Point: The Theater Shipping and Consolidation Point is responsible for the rapid segregation, sorting, and consolidation of multiple consignee shipments from a range of sources and delivery to the customer.

Transportation Control Movement Document (TCMD), DD Form 1384: A form used to control the movement of property while in the Defense Transportation System (DTS). Similar to a bill of lading in the commercial transportation system.

Transportation Service Provider (TSP): Any party, person, agent, or carrier that provides freight or personal property transportation and related services to an agency. In the case of Personal Property Qualification and rate filing, the term TSP will apply to Motor Carrier, Freight Forwarder, and Broker, as applicable.

Transportation Service Provider's Agent/Representative: A business firm, corporation, or individual acting, pursuant to a preexisting agreement on behalf and under the direction of a TSP.

Unaccompanied Baggage (UB): The portion of a customer's prescribed weight allowance of personal property including professional books, papers, and equipment, normally shipped separately from the bulk of personal property and designated as such on the customer's application for shipment. UB is not restricted to dimensions of the container used to pack the items. The customer is limited to their weight entitlement based on grade, with or without dependents. IAW the Joint Travel Regulation, UB includes personal clothing and effects, equipment directly related to the assignment, essential cooking items, light housekeeping items, cribs, playpens, and baby carriages that are required for the care of dependents. Items such as refrigerators, washing machines, and other major appliances or furniture are not unaccompanied baggage.

United States Transportation Command (USTRANSCOM): Commander, USTRANSCOM directs transportation components from the Army, Navy, and Air Force in order to fulfill Defense

Transportation requirements. USTRANSCOM is responsible for all the DoD's surface transportation shipments as well as several core transportation processes.

Introduction

Purpose

1. The International Tender (IT) serves as the principal DoD International Tender that governs the transportation of Household Goods (HHG), Unaccompanied Baggage (UB), personal effects, property, and other similarly defined articles worldwide.
2. This Tender provides guidelines, rules, regulations, and other information required to participate in the movement of personal property worldwide.
3. USTRANSCOM does not endorse any third-party software or products that utilize these files to compute shipment costs. Any discrepancy between such software and these posted rates is no fault of USTRANSCOM. Only rates provided by USTRANSCOM will be the final authority for payment.

Authority

Under responsibilities assigned to the Commander, USTRANSCOM, in the Defense Transportation Regulation (DTR) 4500.9-R. USTRANSCOM is responsible for the negotiation of rates worldwide for shipment of International HHGs and UB. The rates are solicited on behalf of the entire DoD, including civilian appropriated and non-appropriated fund employees, and the U.S. Coast Guard (USCG).

DoD Approved TSP and TSP Representation

1. TSPs participating in this Tender must be DoD approved. A list of DoD approved TSPs can be found at <https://www.ustranscom.mil/dp3/pdfs.cfm>.
2. TSPs shall enter the name and phone number for a valid origin representative within DPS at the time of shipment acceptance. TSPs must update this information to reflect the origin representative who will service the shipment prior to performing the pre-move survey.
3. USTRANSCOM procedures governing disqualification and non-use of TSPs, and their affiliates contracted with USTRANSCOM for transportation and/or storage of DoD sponsored personal property will be followed when USTRANSCOM takes action to disqualify or place a TSP in non-use or recommends that such action be taken.
4. This does not apply to contracts entered into pursuant to the Federal Acquisition Regulation (FAR), unless any such contract calls for its application. Transportation Review Boards (TRB) may consider a TSP's services based on FAR contracts in determining appropriate corrective action, if any.
5. USTRANSCOM may, at its election, continue to honor BL(s), rate tenders, service orders, or similar transportation arrangements that are in existence, at the time the TSP was placed in non-use or disqualified.
6. Any outstanding claims placed against a TSP in non-use or disqualified status, may be transferred by the customer(s) to their Service Claims Office and still be eligible for Full Replacement Value (FRV).

Safeguarding Personally Identifiable Information (PII)

1. All entities entering into contracts with the Federal Government are expected to protect their IT Systems. There are two basic types of protection contractors are expected to apply to

their IT systems for unclassified information, (a) Basic and (b) Controlled Unclassified Information (CUI). (FAR 52.204-21, [https://www.acquisition.gov/far/part-52#FAR 52 204 21](https://www.acquisition.gov/far/part-52#FAR%204%2021))

- a. Basic. All contractors are expected to maintain this level of security. This includes the typical controls any commercial entity would employ to protect their information and are enumerated in FAR 52.204-21(b) (1) (i)-(xv). This includes controls like escorting visitors, sanitizing storage discs before disposing, and changing passwords.
- b. CUI. Contractor's packing, loading, transporting, or stowing HHGs are exposed to DoD personnel's personally identifiable information (PII) in the performance of their contract. In addition to customer's current personal address, phone number and often e-mail, TSPs also have access to customer's new location as well as their Social Security Number. This PII is stored and used by every company in the HHG program and must receive the commensurate level of protection from those entities. Consequently, in addition to the basic protection, contractors that manage PII in their own or purchased environment(s) require additional security controls as outlined in NIST SP 800-60. This ensures contractors maintain adequate security (DFARS 252.204-7012 (b)) and comply with Cyber incident reporting requirements (DFARS 252.204-7012 (b)) should a breach occur. (<https://www.acquisition.gov/dfars/part-252-solicitation-provisions-and-contract-clauses#DFARS-252.204-7012>)
- c. Contractors who subcontract portions of their work are required to include the substance of this paragraph in their agreements.

Presidential Executive Orders

TSPs are responsible for adhering to all Presidential Executive Orders (PEO). Failure to Comply with PEOs may result in administrative actions.

Altering Government Documents

When issued a BL, the TSP/Agent will not redact, modify, or remove any information on the BL issued to move DoD HHG/UB. The government is the only authorized agency who can redact, modify, or remove information on the BL through an SF1200.

Application and Scope

(LHS) - Linehaul Transportation

(LHSADJ) - Linehaul Adjustment

(LHSREF) - Refund of Excess Linehaul

1. This Tender is applicable to DoD approved TSPs eligible to transport HHGs, UB, and boat shipments between designated rate areas including inter-theater, intra-theater, and intra-country.
2. The International program operates utilizing a Single Factor Rate (SFR). The transportation SFR, per net hundredweight for HHG and per gross hundredweight for UB, filed with USTRANSCOM, including shipments between or within overseas (inter-theater/intra-theater) commands applies from origin area to destination area, on shipments controlled by and moving on a BL.
3. The SFR includes the following services:

-
- a. Includes packing and pickup at any point within the origin area and delivery and unpacking to any point within the destination area.
 - b. Packing/Unpacking:
 - (1) Use of cartons/containers and materials from origin to destination.
 - (2) Unpacking of cartons/containers and crates.
 - (3) When Government-owned containers are utilized or when packing/unpacking is not required, reductions to the SFR will be annotated on the BL.
 - (4) Shipping containers and packing materials furnished by the TSP will remain the property of the TSP.
 - c. Servicing and un-servicing of household appliances and other articles which have free moving parts, mechanisms, attachments, or accessories which if not properly serviced might be damaged or rendered inoperative during transit including:
 - (1) Servicing washing machines (e.g., front load).
 - (2) Other household articles that require bracing/stabilization (and unbracing/destabilization) of moveable parts IN or ON such appliances.
 - (3) Servicing will not include disconnecting or reconnecting appliances, repairing articles, removal or installation of TV antennas or air conditioners, wiring, or plumbing service, and securing stereo arms or turntables.
 - d. All "known" customs and agricultural inspection charges.
 - e. Removal and placement of each article in the residence/warehouse or other building.
 - f. Hoisting or lowering of article(s).
 - g. Carries involving (see Item 532 for exceptions):
 - (1) Elevator.
 - (2) Stair.
 - (3) Excessive distance.
 - (4) Piano/organ carry.
 - h. Heavy or bulky item charge.
 - i. Ferry, tunnel, and bridge charges/tolls.
 - j. Pier Pass (<https://www.pierpass.org>) or related charges levied in an attempt to reduce truck traffic and pollution during peak daytime traffic hours and to alleviate port congestion.
 - k. Port security surcharge and War risk surcharge
 - l. All land, water, and air transportation, **EXCEPT**:
 - (1) Additional land transportation charges for shipments picked up or delivered from or to SIT.

-
- (2) Port handling and stevedoring services within the military ocean terminal or within the commercial ocean terminal, when used in lieu of the military ocean terminal.
 - (3) Terminal services within the AMC terminal and Government-arranged air movement.
 - (4) Such charges, where applicable, and when billed to the International TSP by ocean freight TSP, air TSP or port agent pursuant to regularly filed Tender(s) with the Regulatory Bodies or Commissions. These charges will be separately stated on the BL and supported by prorated ocean, air TSP, or port agent invoices for the actual amount.
 - (a) Bunker fuel charges (BSC).
 - (b) Air fuel surcharges (Item 231).
 - (c) Congestion surcharges (CON).
 - (d) Fuel Surcharge (FSC) (Item 513) for CONUS linehaul, including Alaska and Hawaii.
 - (5) Charges for excess linehaul costs, associated with movement in bond, are those expenses over the TSP's normal linehaul operating expenses. Such expenses will be supported by an invoice for the actual charges, along with a copy of the freight agreement or other supporting documentation, to justify the excess cost.
 - (6) Charges to the TSP by agents of the governmental body operating the seaport or air terminal where charges are incurred. Charges will only be considered when DoD specific and/or temporary in nature.
 - (7) Fees that are uniquely associated to the presence of alcohol and supported by a third-party invoice (e.g., broker fees). Third-party providers are prohibited from collecting fees from the customer and TSPs are prohibited from billing customers directly for fees except for excise taxes, duties, and fees assessed on the Customs and Border Protection (CBP) Form 7501 (U.S. Customs and Border Protection Entry Summary).
 - (a) The TSP is responsible to completely clear the shipment through customs. TSPs will submit third-party invoices for charges related to alcohol in shipments for PPSO review. The signed CBP Form 7501 that will indicate the excise taxes due in Block 40. The TSP, not the broker, will provide the customer a copy of the CBP Form 7501 along with a copy of the invoice for their record. The TSP will coordinate with the customer for refunding only the fees assessed by CBP on the Form 7501 in block 40.
 - (b) If the TSP uses a licensed broker to customs clear a shipment containing alcohol, the TSP is authorized reimbursement for the fee(s). The TSP, not the broker, will submit an invoice (excluding the excise taxes levied on the CBP 7501 in block 40) for the broker fee(s) to the Origin PPSO with supporting documentation (e.g., broker's invoice, CBP Form 7501, etc.). The TSP will invoice using Item Code 223A with a note explaining (i.e., broker fee(s) for alcohol shipment, see documentation).
4. Advise the destination PPSO by electronic transmission (including detailed notes in the Additional Remarks section of the DPS shipment record) in advance of the RDD with the

reason for delay and specify the date the shipment will be available for delivery in the event a shipment cannot be delivered by the RDD.

5. UB: All items in paragraph 3 above apply.
6. OTOs: See Chapter 7 for exceptions to the application of the SFR.

Pass Through Requirements

1. In circumstances where a TSP elects to subcontract for any portion of HHGs movement by truck, the TSP shall be required to pass through any charges paid by the Government to the TSP to the person(s), corporation(s), agent, HHGs carriers, HHGs freight forwarders, or other authorized TSP(s) that bears the cost for any shipment(s), or any portion thereof, transported under this guidance. TSPs shall insert a clause that meets the intent of this requirement in any subcontract with any motor carrier or HHGs freight forwarder, or other person or entity at any tier authorized to transport HHGs shipments.
2. For the convenience of TSPs, a sample provision implementing this requirement is provided herein as follows:
 - a. "TSP agrees that it shall be solely responsible to pass through and pay subcontractor any charges associated with crating, shuttle service, additional labor, Florida Keys Service Charge, all SIT related charges (i.e., delivery into origin SIT, delivery out of destination SIT, SIT 1st Day, Warehouse Handling, and Additional Days of Storage), and fuel surcharge for the relevant portion of these services actually performed by subcontractor for sums actually paid to TSP for DoD HHG shipment(s) utilizing these services.
 - b. TSP agrees that any crating, shuttle service, additional labor, Florida Keys Service Charge, all SIT related charges (i.e., delivery into origin SIT, delivery out of destination SIT, SIT 1st Day, Warehouse Handling, and Additional Days of Storage), and/or FSC amount owed to subcontractor shall be paid immediately upon TSP's receipt of payment from DoD.
 - c. TSP and subcontractor agree that in no event shall subcontractor be entitled to file a transportation claim directly with the U.S. Government, or that the subcontractor shall have a cognizable or valid claim directly against the Government due to failure or refusal of a TSP to pay any subcontractor any lawfully owed costs actually incurred by subcontractor."
3. In no event shall this legal requirement be interpreted to provide any subcontractor lacking privity of contract with the U.S. Government with legal standing to assert a transportation claim for payment pursuant to 31 U.S.C. 3726 against USTRANSCOM, or the DoD due to a TSP's failure to insert the required clause in any subcontract, or the failure of a TSP to otherwise properly comply with the FSC pass through requirement established by Section 884 of the 2009 National Defense Authorization Act.
4. TSPs who fail to comply with the requirements of this provision may be subject to administrative action.

TSP Correspondence

TSPs are prohibited from distributing any correspondence dealing with information in conflict with international program instructions furnished to PPSOs.

Chapter 1: Regionalization

As of 01 January 2019, all planned Regionalization's have been completed. Please refer to the State GBLOC Item 500 Table located in Chapter 5 of this Tender and/or the PPCIG.

Chapter 2: Policy and Procedures

Item 200 - Application of Tender

1. This Tender is applicable to shipments transported for the account of the DoD, including the Army, Air Force, Navy, Marine Corps, and the Coast Guard; herein called the Government. It applies on the transportation of personal property (HHG and UB) between rate areas within CONUS (excluding Hawaii), overseas rate areas (including Hawaii), and between rate areas within overseas (inter-theater/intra-theater) commands, to include intra-country moves (e.g., Germany to Germany).
2. IAW provisions of this Tender and applicable rate tables, all accessorial rates and approved charges will be based on the actual pickup date as identified in the Item Code Listing located at <https://www.ustranscom.mil/dp3/pdfs.cfm>.
3. The applicable SFR that applies is based on the requested pickup date at the time the shipment is offered and accepted by the TSP. If TSP or customer negotiates a change in the pickup date the prevailing applicable rate will remain the one in effect on the requested pickup date at the time the shipment is offered and accepted by the TSP (e.g., if TSP or customer negotiates a new pickup date that crosses into a new annual rate cycle the rate effective on the original requested pickup date will apply).
4. Unless otherwise stated, all rates and charges are expressed in U.S. dollars and cents per hundredweight (cwt).
5. To file rates, TSPs must have satisfied all administrative requirements for DoD qualification and possess a current Certificate of Independent Pricing (CIP)/Certificate of Responsibility (COR).
 - a. The TSP must verify that rates filed are the result of independent pricing determinations.
 - (1) This verification includes:
 - (a) Completing the CIP/COR in DPS with the understanding that the CIP is agreed to as listed in Attachments, Figure 1.
 - (b) TSPs wishing to utilize an automated data processing (ADP) agent and/or a representative using a DPS Rate Filing User role must ensure:
 - 1 The selected third-party ADP agent and/or a representative using a DPS Rate Filing User role is in compliance with all state and federal antitrust laws.
 - 2 The USTRANSCOM non-disclosure agreement is in place if you are utilizing a third-party ADP agent and/or a representative using a DPS Rate Filing User Role. This completed form must be provided upon request (see Attachments, Figure 2).
 - (2) The CIP/COR must be resubmitted annually in DPS prior to rate filing.
 - b. Any TSP not filing rates for two consecutive rate cycles may have their market approval revoked, thereby precluding participation in future rate cycles.
6. TSPs filing rates in response to this Tender must submit rates in the Defense Personal Property System (DPS).

7. USTRANSCOM reserves the right to reject any or all offers; to waive informalities in offers received; to negotiate, accept, or reject initial or subsequent submissions without discussion of rates; to non-use or cancel any rate upon 15-day notice; and re-solicit rates. Acceptance of rates does not result in a requirement for a contract.
8. USTRANSCOM reserves the right, with a 15-day notice, to:
 - a. Extend the effective period of rates by 45 days to modify the rate filing period;
 - b. Change the type of rates being solicited;
 - c. Re-solicit rates as a result of Government or TSP actions; and/or
 - d. Take any appropriate action to protect the Government's interests in response to delaying court injunctions, data processing failures, strikes, embargoes, and other policy or economic situations.
9. TSPs are responsible for establishing quality controls and procedures that review their proposed rates prior to actual submission and ensure they have the necessary operating authorities to file those rates.
10. When filing DP3 rates, TSPs assume any risks associated with cost variables related to any subcontractor or supporting service provider (e.g., claims, invoicing, etc.). DoD will not reimburse or allow pass through of any such charges, nor will those charges be considered accessorial costs.
11. TSPs who choose to file rates are encouraged to incorporate any potential cost variables into their rate formulation prior to filing their DP3 rates.

Item 201 - Minimum Weight

1. Except as otherwise stated in this Tender, the transportation SFR, and all other charges based on weight, are based on the weight of the shipment with the following minimums:
2. HHG - 500 lbs. net.
3. UB - 350 lbs. gross (if actual gross weight is less than 350 lbs., TSP will invoice the weight of 350 lbs.).
4. All weight calculations are based on lbs.

Item 202 - Determination of Weight

1. Weighing Requirement: TSPs will determine the weight of each shipment transported prior to the assessment of any charges depending on the shipment weight. Except as otherwise provided in this item, the weight shall be obtained on a scale meeting the definition of a certified scale as provided in Code of Federal Regulations (CFR) Title 49, Part 375.103.
2. Weighing Procedures - HHG:
 - a. Except as otherwise provided herein, the weight of each shipment will be obtained by determining the difference between the tare weight of the vehicle on which the shipment is to be loaded prior to the loading and the gross weight of the same vehicle after the shipment is loaded, or the gross weight of the vehicle with the shipment loaded and the tare weight of the same vehicle after the shipment is unloaded.

-
- b. At the time of both weighings, the vehicle must have installed or loaded all pads, dollies, hand trucks, ramps, and other equipment required in the transportation of each shipment. Neither the driver nor any other persons shall be on the vehicle at the time of either weighing.
 - c. All fuel tank(s) on the vehicle shall be full at the time of each weighing or, in the alternative, no fuel may be added between the two weighings when the tare weighing is the first weighing performed.
 - d. The trailer of a tractor-trailer vehicle combination may be detached from the tractor and the trailer weighed separately at each weighing providing the length of the scale platform is adequate to accommodate and support the entire trailer at one time.
 - e. Shipments may be weighed on a certified platform or warehouse scale prior to loading for transportation or after unloading.
 - f. The net weight of shipments transported in containers must be the difference between the tare (empty) weight of the container, including all pads, blocking, and bracing used or to be used in the transportation of the shipment and the gross (full) weight of the container with the shipments loaded therein (CFR Title 49, Part 375.509).
 - g. The shipper or any other person responsible for payment of the freight charges must have the right to observe all weighings of the shipment.
 - (1) TSPs must advise the shipper, or any other person entitled to observe the weighing, of the time and specific location where each weighing will be performed and must give that person a reasonable opportunity to be present to observe the weighing.
 - (2) Waiver by a shipper of the right to observe any weighing or reweighing is permitted and does not affect any rights of the shipper under these regulations or otherwise.
 - h. TSP may substitute manufacturer's weight for automobiles, trucks, vans, motorcycles, campers, and boats in lieu of obtaining separate weight tickets on these articles whenever such articles are included within a shipment. Manufacturer's weight will be obtained from either the
 - (1) Branham Automobile Reference Book,
 - (2) National Automobile Dealers Association (NADA) Official Used Car Guide,
 - (3) other appropriate reference sources of manufacturer's weight, or
 - (4) shipper may provide TSP with copies of manufacturer's documents evidencing the weight of the article included in a shipment, unless weighed as part of the gross weight of the shipment.
 - i. When Professional Books, Papers, and Equipment (PBP&E) are included as part of the shipment, the weight of such articles will be annotated separately on the BL.
 - (1) The weight may be obtained using bathroom or platform-type scales.
 - (a) In the event scales are not readily available, a constructive weight of 7 lbs. per cubic foot (cu ft) will be used.
 - j. When a gun safe(s) is included as part of the shipment, the weight of such articles will be annotated separately on the inventory next to the line item.

- (1) The weight may be obtained using the manufacturer's weight on the data plate.
 - (a) In the event the gun safe(s) do not have a data plate, a constructive weight of 25 lbs. per cu ft will be used.
 - (b) Small gun safes (drawer safes or similar pistol/handgun safes) without data plates may be weighed using a bathroom or platform-type scale.
 - k. If authorized by the PPSO, TSPs may use Government scales to determine the gross, tare, and net weight of shipments not originating on Government installations. When requested by the PPSO, Government scales will be used to weigh or reweigh shipments originating or terminating at Government installations where such scales are available.
3. Weight Tickets:
- a. Per 49 CFR 375.519, TSP must obtain a separate weight ticket for each weighing. The weigh master must sign each weight ticket. Each weight ticket must contain the following six items:
 - (1) The complete name and location of the scale.
 - (2) The date of each weighing.
 - (3) The identification of the weight entries as being tare, gross, and/or net weights).
 - (4) The company or carrier identification of the vehicle.
 - (5) The last name of the individual shipper as it appears on the bill of lading.
 - (6) The carrier's shipment registration or bill of lading number.
 - b. When both weighings are performed on the same scale, one weight ticket may be used to record both weighings.
 - c. As part of the file on the shipment, you must retain the original weight ticket or tickets relating to the determination of the weight of a shipment.
 - d. All invoices presented to collect any shipment charges dependent on the weight transported must be accompanied by true copies of all weight tickets obtained in the determination of the shipment weight.
4. UB Weighing Procedures: The gross weight will be used in determining charges on the transportation SFR and all other charges based on weight. The gross weight will be determined by scale weight, except where an adequate scale is not available at origin or at destination (when physically delivered to destination transportation office). In such instances, a constructive weight based upon 7 lbs. per cu ft shall be used in determining the applicable charges when authorized by the PPSO.
5. Additional Weighing Procedures for Overseas Areas: Weight tickets must be signed by a certified weigh master. If one is not available, the TSP or their representative must sign a weight certificate in lieu of the certified weight tickets.

Item 203 - Governing Regulations

1. International shipments are subject to the terms and conditions of the BL, the rules and regulations contained herein, and the TSP Tender on file with USTRANSCOM. Where rates

or other services are based on mileage, Defense Table of Official Distances (DTOD) shall be used.

2. TSP will not render, nor will the Government pay for, any service not authorized herein.

Item 204 - Designation of Overseas Theater Command Areas

1. Rate areas that fall within the below Theater Commands are considered components of the responsible DoD Commands.
2. Rates filed with USTRANSCOM that apply
 - a. between rate areas within the same overseas theater are intra-theater rates.
 - b. from a rate area in one theater to a rate area in another theater are inter-theater rates.



DoD Commands

Item 205 - Reserved for Future Use

Item 206 - Holidays

1. Except as otherwise specifically provided in this Tender reference to the term "holiday" will be the date such U.S. national, foreign, or officially declared state holidays are observed.
2. When a holiday falls on a Saturday, the holiday will be observed on the preceding Friday. When a holiday falls on a Sunday, the holiday will be observed on the following Monday.
3. Charges for holidays in this Tender shall apply only when service is rendered on an observed holiday. Any service performed on a weekend or holiday where the TSP is seeking additional compensation, must be preapproved by the PPSO. Union negotiated holidays do not fall into this category.
4. For reference purposes only, U.S. National Holidays are:

New Year's Day	January 1st
Martin Luther King, Jr's. Birthday	The Third Monday in January
Presidents Day	The Third Monday in February
Memorial Day	The Last Monday in May
Juneteenth National Independence Day	June 19th
Independence Day	July 4th
Labor Day	The First Monday in September
Columbus Day	The Second Monday in October
Veterans Day	November 11th
Thanksgiving Day	The Fourth Thursday in November
Christmas Day	December 25th
Inauguration Day	January 20th of each fourth year after 1965, is a holiday for the Washington, DC area only.

Item 207 - Hourly Rates

1. Charges based on time shall be computed by multiplying the hourly rate by the time involved.
2. Unless otherwise provided, fractions of an hour will be disposed of as follows:
 - a. Where the time involved is 15 minutes or less, the charge shall be for 1/4 hour.
 - b. When more than 15 minutes but not more than 30 minutes, the charge shall be for 1/2 hour.
 - c. When more than 30 minutes but not more than 45 minutes, the charge shall be for 3/4 hour.
 - d. When more than 45 minutes, but not more than 60 minutes, the charge shall be for 1 hour.

Item 208 - Advanced Charges

1. Charges advanced by the TSP for services of others engaged at the request of the PPSO will be supported by the TSP with a copy of invoice setting forth services rendered, charges and basis thereof, together with reference to applicable schedule or Tender if charges are assessed in accordance therewith.
2. The advanced charges are in addition to and shall be collected with all other lawful rates and charges.

Item 209 - Reserved for Future Use

Item 210 - Impractical Operations

1. Nothing in this Tender shall require the TSP, TSP's hauling contractors, TSP's customers, and/or TSP's agents to perform any service at any point or location where, through no fault or neglect of the TSP, the furnishing of such services are impracticable because:
 - a. Conditions of roads, streets, driveways, alleys or approaches thereto would subject operations to unreasonable risk of loss or damage to life or property,
 - b. loading or unloading facilities are inadequate,

- c. any force majeure, war, insurrection, riot, civil disturbance, strike, picketing, or other labor disturbance would
 - (1) subject operations to unreasonable risk of loss or damage to life or property, or
 - (2) jeopardize the ability of the TSP to render linehaul or pickup or delivery or any other service from, to, or at other points or locations.
 - d. local, state, or federal restrictions, regulations, or laws prohibit performance of such services by linehaul equipment.
2. TSPs can utilize third-party service to accomplish these tasks when necessary and approved by the Government (see Item 534).

Item 211 - 212 - Reserved for Future Use

Item 213 - Removal or Placement of Property From or To Inaccessible Locations

1. The customer is responsible for removal or placement of property from or to attics, basements, and other locations, and to make property available to the TSP where the location of property and goods to be shipped or delivered
 - a. is not accessible by a permanent stairway (does not include ladders of any type),
 - b. is not adequately lighted,
 - c. does not have a flat continuous floor, and
 - d. does not allow a person to stand erect.
2. When the PPSO requests and approves the removal or placement of property from or to such areas not readily accessible, labor charges are authorized.

Item 214 - 219 Reserved for Future Use

Item 220 - Performance and Data Periods

1. The performance periods over which TSPs will be evaluated under this Tender, and the corresponding Performance Period data cutoffs for calculating Customer Satisfaction Survey (CSS) scores, are as follows:

Performance Periods	Data Periods for CSS
1 January - 14 May	1 February - 31 October
15 May - 31 July	1 April - 31 December
1 August - 30 September	1 September - 31 May
1 October - 31 December	1 November - 31 July

2. Performance Scores are calculated and re-ranking of TSPs occurs at the end of each performance period. CSS score used for these performance periods consist of the past nine months of data with the cutoff dates shown above. Ranking is based on a TSPs Best Value Score (BVS) with the Performance Score calculated per shipment market and the Rate Score (RS) calculated for each channel and COS combination in DPS. See DTR Part IV Chapter 403 for additional details on BVS and how performance periods apply.

Item 221 - Use of Foreign Flag Shipping

(221A) Foreign Flag Adjustment

1. Ships registered under the laws of the United States must be used for the carriage of personal property (HHG, personal effects, or POVs) when such ships are available unless the necessity of the traveler's mission requires the use of a ship under a foreign flag.
2. An approval from HQ SDDC, including control number for vessel or a Self-Certification Statement for air (see HHG Foreign Flag Waiver Request Form below) is required for the use of a foreign flag vessel/aircraft. This requirement applies even if a US flag vessel/aircraft is used for part of the voyage.
3. Rate adjustments will be permitted when rate differentials are involved due to use of foreign flag shipping. Differences between the foreign flag vessel/aircraft rate and the rate used in computing the transportation SFR on file at USTRANSCOM, ocean/airfreight bill must be submitted to support each BL rate adjustment request.
 - a. An example of the adjustment required in the event of a foreign flag shipping decrease: 3,000 lbs., 450 cu ft, International Single Factor Rate \$ 134.00 per cwt
 - (1) 3,000 lbs. (30 cwt) X \$ 134.00 per cwt = \$ 4,020.00
 - (2) Ocean rate used in constructing the International Single Factor Rate: \$ 1.75 per cu ft.
 - (3) Amount paid to Foreign Flag Ocean TSP as shown on freight bill: .90 cents per cu ft.
 - (4) Rate Adjustment: Subtract foreign flag rate from Ocean rate: \$ 1.75 - .90 = .85 cents per cu ft. 450 cu ft at .85 cents per cu ft = \$ 382.50
 - (5) \$ 4,020.00 - \$ 382.50 = \$ 3,637.50 (adjusted shipment cost)
 - b. Refund due to the Government: \$ 382.50
4. When it is determined use of a vessel of United States registry will not provide the required service, the International TSP will request permission to use a foreign flag vessel prior to start of movement as follows:
 - a. Air shipments:
 - (1) To assure compliance with the Fly America Act (49 USC 40118), air carriers and freight forwarders must provide the below self-certification with their invoice/payment request when it is necessary to select a non-U.S. Flag carrier for international air transportation. For questions pertaining to the Fly America Act please contact the Department of Transportation, Office of International Aviation at (202) 366-2380 or visit their website at <http://www.dot.gov/policy/aviation-policy>.
 - (2) When it is determined use of an aircraft of U.S. registry will not provide the required service during any segment of the routing to or from the U.S., the BL carrier will self-certify to use a foreign flag aircraft prior to start of the movement. Questions concerning self-certification, or this procedure may be addressed to USTRANSCOM.
 - (3) Air shipments moving between overseas areas are exempt from having to obtain a foreign flag certificate.
 - (4) The following principles shall be followed in determining the availability of U.S. Flag air TSP: The first or last leg from and to the U.S. shall be by a U.S. Flag TSP. U.S.

Flag air TSP service available at the point of origin shall be used to destination or, in the absence of direct or through service, to the furthest point on a commonly used air route. When an origin or interchange point is not serviced by a U.S. air TSP, foreign flag air TSP service shall be used only to the nearest interchange point on a commonly used air route to connect with U.S. Flag air TSP service.

b. Surface shipments:

- (1) U.S. Flag vessels participating in the Voluntary Intermodal Sealift Agreement (VISA) will receive preference over other vessels. See Item 229 for the prioritized order for utilization of commercial sealift capacity to meet DoD peacetime and contingency requirements.
- (2) Approval for use of a foreign flag vessel (whether for part or all of the voyage) must be requested by e-mail from HQ SDDC at the e-mail address at the end of this item.
 - (a) The request may come from the TSP or their agent (e.g., consolidator), and
 - (b) Must include the information identified in this section for each shipment covered by the request.
- (3) Use of foreign flag vessels is not authorized when the International HHG TSP, for its convenience, selects a port of loading where ocean transportation is available only by foreign flag vessel in lieu of a port customarily served by U.S. Flag vessels. Therefore, when a TSP, elects to use a port not normally serviced by U.S. Flag vessels, HQ SDDC may not approve use of a foreign flag vessel. It is understood by the TSP the selection of such a port is at its risk should it become necessary to divert the shipment to a port providing U.S. Flag vessel service.
- (4) The movement of cargo partly by U.S. Flag vessel and partly by foreign flag feeder vessel will not be approved when a U.S. Flag vessel is available to transport HHG to their destination. TSP's agents may, if authorized in writing by the TSP, make the submission on behalf of the TSP. HQ SDDC will furnish advice to TSPs as to the general availability of U.S. Flag vessels between specified origin and destination places when requested. If any segment of the intended routing involves use of a foreign flag vessel, the TSP may not finalize arrangements using a foreign flag vessel for any part of the journey without receiving a HQ SDDC approval memo.
- (5) The request for authorization to use a foreign flag TSP will be accomplished and submitted to the appropriate HQ SDDC office by e-mail (or facsimile by prior telephonic arrangement should e-mail not function) IAW the following:
 - (a) Not more than 15 calendar days following the date of HHG pickup.
 - (b) Not less than 7 calendar days prior to booking cargo with a Vessel Operating Common Carrier (VOCC).
 - (c) TSPs will submit request by e-mail to the HQ SDDC organizational e-mail account listed below.
- (6) Requests for a foreign flag waiver must be:
 - (a) In the format prescribed by HQ SDDC and accompanied by the HHG Foreign Flag Waiver Request form below containing data elements for the shipment.

-
- 1 This spreadsheet can be requested at the e-mail address below.
 - 2 The Justification Certificate below will be submitted in conjunction with the spreadsheet for waiver requests.
- (b) Accompanied by e-mail attachments of correspondence from two or more US flag carriers providing service on or near the lane in question indicating that full US flag service is not available.
- 1 Contact information for the representatives of US flag carriers can be provided upon request.
 - 2 The correspondence must be actual e-mail traffic within the previous 30 days between the TSP or their representative and the carriers regarding the specific ocean lane.
 - 3 Screen shots of internet vessel schedules do not meet this requirement.
- (c) Accompanied by a copy of the BL for each shipment for which a waiver is requested. If, for example, two separate shipments are in the same container and managed by the submitting TSP, two BLs must be attached, along with two rows of the required spreadsheet information.
- (d) Clear as to the level of waiver requested, either P3 (all foreign flag) or P2 (partial foreign flag, partial US flag). If P2, indicate the US flag leg, and the foreign flag leg.
- (e) Accompanied by an explanation - if a higher level of US flag service (e.g., P1 or P2) is available why a lower-level US flag is being requested. For example, a shipment from Bahrain to USA for which US flag service is available transpacific but not transatlantic and using the US flag transpacific will jeopardize the RDD.
- (f) Submitted in a timely fashion.
- 1 If the request is not submitted in a timely fashion
 - a the request is subject to disapproval especially if a US flag vessel was available to meet the requirement had the request been made in a timely manner.
 - b the request must be accompanied by an explanation of why it is tardy.
 - c consideration of an untimely filed certificate will be at the discretion of the HQ SDDC reviewing official.
 - 2 No late requests will be considered unless TSP fully documents all extenuating circumstances preventing an on-time request and such circumstances are deemed substantive cause for late filing by HQ SDDC reviewing official. Any subsequent reconsideration will be by HQ SDDC.
 - 3 In all instances, HQ SDDC will respond within 7 calendar days of receipt of certificate request.
 - a Limited attempts may be made by HQ SDDC within that timeframe to
 1. resolve minor factual omissions or

2. clarify supporting information.
 - b Response to TSP will be by electronic transmission.
5. TSPs may not hold cargo (whether for consolidation or for other reasons) beyond the relevant deadlines of the latest US flag vessel or combination of vessels available for delivery by RDD.

**HQ SDDC
ADDRESS/COMMUNICATION**

Official Mail Address

Telephone, FAX

HQ SDDC
 International Sealift Contract Mgmt. e-mail: usarmy.scott.sddc.mbx.g3-ffw-team@army.mil
 Soldier Way, Scott AFB, IL 62225

Payment: Certificates not having an AMC/DSC control number will cause TSPs billing to be rejected and is grounds for post pay audit action. Payment requires a properly completed justification certificate.

HHG Foreign Flag Waiver Request Form

FFW Request Form may be requested by emailing usarmy.scott.sddc.mbx.g3-ffw-team@army.mil.

Turn in / Pick up Date	RDD	Service Member	Origin	Requested POE	Requested POD	Destination	# of Pieces	POV / HHG	Requested Service (Level)	Please Leave Blank	SCAC (Carrier)	GBL or Order #	Remarks	Requestor

JUSTIFICATION CERTIFICATE FOR USE OF A FOREIGN FLAG OCEAN VESSEL

HQ SDDC CONTROL #: _____ SUBMISSION DATE: _____

HQ SDDC Receipt Date: _____

TSP: _____

SCAC: _____

Award Date: _____

BL #: _____

OTO #: _____

Pickup Date: _____

RDD: _____

Origin: _____

Destination: _____

Property owner's name and rank: _____

Name of Foreign Flag TSP: _____
(Legal name of operator)

Foreign flag TSP will be utilized between _____ on _____
(Port of Embarkation) (Date of Embarkation)

_____ arriving at _____ on _____
(Name of vessel & voyage number) (Port of Debarkation) (Date of Debarkation)

I certify that it is necessary to transport the household goods and/or personal effects of the above-named property owner by foreign flag TSP as designated above for the following reasons:

(A FULL EXPLANATION IS REQUIRED)

Note 1: The explanation must include documented description of efforts made to secure U.S. Flag TSP (including points of contact (names & telephone numbers and copies of e-mail traffic to/from U.S. Flag Ocean Carriers indicating non-availability) with at least two (2) U.S. Flag Carriers contacted.

Note 2: TSP must provide a detailed list of all BLs they are requesting to be moved under the Foreign Flag waiver request. The request will contain Customers First and Last Name, BL #, Weight, and RDD for all shipments tendered to them.

(Signature of TSP Official)

(Title)

(Date)

Attached:

BL: Yes / No

OTO Award Message: Yes / No

(If no, provide explanation.)

Note 3: The BL rate on file with USTRANSCOM will be protected to the extent provided IAW the applicable International Tender.

Note 4: HQ SDDC's e-mail response to each individual FFW request will serve as the official decision and provide the HQ SDDC certification for all approved FFW requests.

Statement of Non-Availability of U.S. Flag Air Carriers

International air transportation of property by U.S. Flag air carriers was not available and/or it was necessary to use foreign flag air carrier service for the following reasons:

Shipment Identification: _____

I certify that it was necessary for _____ to use _____
(Forwarder / SCAC) (Foreign Flag Carrier)

between _____ and _____ enroute from _____ to _____ on _____
(Date)

due to the following reason(s): _____

(Include description of efforts made to obtain US Flag service and copies of e-mail traffic to/from U.S. Flag Airlines indicating non-availability.)

Transportation Service Provider's Signature

Date

Item 222 - Air Clearance Authorities**1. Army Airlift Clearance Authority:**

Telephone: Commercial: (256) 955-0874 DSN: 645-0874
 Fax: Commercial: (256) 955-0097 DSN: 645-0097
 e-mail: usarmy.redstone.logsa.mbx.aaca@mail.mil

2. Navy Airlift Clearance Authority:

Telephone: Commercial: (757) 443-5434 DSN: 646-5434
 Fax: Commercial: (757) 443-5438 DSN: 646-5438
 e-mail: navsup_wss_air_clear@navy.mil

3. Air Force Airlift Clearance Authority:

Telephone: Commercial: (618) 256-1773 DSN: 576-1773
 e-mail: afglsc.sc3aca@us.af.mil

4. Marine Corps Airlift Clearance Authority:

Telephone: Commercial: (760) 577-7875/7660 DSN: 282-7875/7660
 Fax: Commercial: (760) 577-7643 DSN: 282-7643

Item 223 - Customs/Agricultural Inspection Charge - HHG

(223A) - Customs Inspection Charge - HHG

(223B) - Agricultural Inspection - HHG

1. TSP will arrange all customs clearance, agricultural and other related services that pertain to and influence the movement of personal property (gun control, quarantine, pest infestation, etc.) and will comply with all DoD, foreign, and domestic regulations.
2. Export and import documentation services involving customs clearances; movement of shipment arriving in CONUS, in bond, to the U.S. Customs House nearest the ultimate consignee. The responsible destination PPSO will be notified in advance when a shipment is to move in bond.
3. TSPs may invoice for unknown customs and/or agricultural inspection charges. TSP must provide a copy of the invoice to support all fees/charges. Fees/charges are subject to JPPSO/PPSO approval and may include (but are not limited to):
 - a. Handling charges caused by failure of the origin Transportation Office to furnish acceptable customs documents or by refusal of customs officials to clear shipments.
 - b. Agricultural and VACIS (Vehicle and Cargo Inspection System) inspections, dis-infestation, decontamination, fumigation, demurrage, or other charges not the fault of the TSP and that are random and infrequent in nature such that it is impractical for any TSP to include these charges in their SFR.

- c. All Inbound shipments to Guam, with documented Privately Owned Firearm(s) (POF) and/or motorcycle(s) must be accompanied by an official invoice issued by the Guam Container Freight Station (CFS).
- (1) For shipments with POF(s) an approved charge of **\$1.00** per cu ft of all HHGs containers (crates) identified under the BL shipment.
 - (2) For shipments with motorcycle(s) an approved charge of **\$1.00** per cu ft of the Motorcycle crate only identified under the BL shipment.

Item 224 - Customs/ Agricultural Inspection Charge - UB

(224A) - Customs Inspection Charge - UB

(224B) - Agricultural Inspection - UB

All information contained under Item 223 applies.

Item 225 - 226 Reserved for Future Use

Item 227 - Pickup at or Delivery to a Military Terminal

1. Upon delivery of a shipment to a military air or ocean terminal, the TSP agrees to provide the terminal PPSO with a memorandum copy of the BL describing the shipment.
2. When notified that an entire shipment is available for pickup at a military terminal (air or water) the TSP will pick up the shipment as soon as possible, but not later than
 - a. one workday for military air terminals and not later than,
 - b. five workdays for military water terminals from date of receipt of notification.
3. If the shipment is not removed within that period, the terminal PPSO has the option of charging storage in accordance with the rate Tender beginning on the second or sixth day (whichever is appropriate) and/or terminating the BL and issuing a new BL for onward movement by the same or different mode/method of transportation. If the shipment is not removed within that period, the terminal PPSO has the option of charging storage in accordance with the rate Tender beginning on the second or sixth day (whichever is appropriate) and/or terminating the BL and issuing a new BL for onward movement by the same or different mode/method of transportation.

Item 228 - General Average/Salvage

On ocean shipments, in addition to its Tender, the TSP assumes full liability for and will pay all contribution in general average or salvage assessed against personal property and will provide bonds or make arrangements for the prompt release of the shipments from any maritime lien arising there from.

Item 229 - DoD Peacetime and Contingency (VISA) Sealift Requirements

1. The Secretary of Defense has approved the Voluntary Intermodal Sealift Agreement (VISA) as a sealift readiness program for the purpose of Section 909 of the Merchant Marine Act of 1936, as amended (46 App. U.S.C. 1248)
2. The objective of VISA is to provide DoD a coordinated, seamless transition from peacetime to wartime for the acquisition of commercial sealift and intermodal capability to augment DoD's organic sealift capabilities.

3. VISA is designed to create close working relationships between the Maritime Administration (MARAD), U.S. Transportation Command, and participants through which contingency needs and the needs of the civil economy can be met by cooperative action. During contingencies, participants are afforded maximum flexibility to adjust commercial operations by TSP Coordination Agreements (CCA), in accordance with applicable law.
4. TSPs must comply with the VISA priorities listed below for the ocean portion of the overall movement. For the purpose of this item, to allow VISA participants the first opportunity to directly meet DoD requirements, the underlying Ocean Bill of Lading (OBL) must be issued by a VISA participant to qualify for priorities (1), (3), and (5).
 - a. U.S. Flag vessel capacity operated by a participant and U.S. Flag Vessel Sharing Agreement (VSA) capacity of a participant.
 - b. U.S. Flag vessel capacity operated by a non-participant.
 - c. Combination U.S./foreign flag vessel capacity operated by a participant and combination U.S./foreign flag VSA capacity of a participant.
 - d. Combination U.S./foreign flag vessel capacity operated by a non-participant.
 - e. U.S. owned or operated foreign flag vessel capacity and VSA capacity of a participant.
 - f. U.S. owned or operated foreign flag vessel capacity and VSA capacity of a non-participant.
 - g. Foreign-owned or operated foreign flag vessel capacity of a non-participant.

Item 230 - Release of Cost Data

Proprietary rate and cost data, submitted by TSPs upon request of USTRANSCOM, is not releasable under the Freedom of Information Act.

Item 231 - Surcharge

(231A) - Air S/C

(BSC) - Bunker S/C

(CON) - Port Congestion S/C

1. **Surcharge** - An extra fee, levied to a shipment, paid by the TSP, and sometimes reimbursed by the U.S. Government. Except for those 5 surcharges identified below, surcharge reimbursement is considered on a case-by-case basis with reimbursement decision resting at the sole discretion of USTRANSCOM. TSP Specific surcharge definitions are provided below:
 - a. **Air Fuel Surcharge (231A)** - An extra charge that is charged to the TSP by the air carrier. This surcharge is applicable to codes of service 6 and 8.
 - b. **Bunker Surcharge (BSC)** - An extra charge, also known as Bunker Adjustment Factor (BAF) or Fuel Adjustment Factor (FAF), sometimes added to ocean TSP rates to offset for the additional cost of the ships' bunker fuel beyond the normal cost included in the ocean freight rate. This surcharge is applicable to COS 4 and 7 and allowed as a pass-through charge when supported by an ocean bill documenting bunker fuel charges as paid by the TSP for fuel that powers the engine of a ship. BSC is based on Port-to-Port movement of shipment by vessel. There will be no land cost included in the BSC.

- (1) BSC compensation may be approved if the TSP provides supporting documentation showing the BSC calculation with auditable documentation showing the BSC charged by the Ocean Carrier. This may include a copy of the OBL from the actual Ocean Carrier or an invoice from a third party or freight forwarders but ONLY if it includes either direct documentation from the Ocean Carrier or a web link to an Ocean Carrier website. Currently BSC/FAF can be verified on these websites: Seaco Shipping SA at <https://gosselingroup.eu/en/seacoshippingsa> and Trans-Pacific American Flag Berth Operators (TPAFBO)) at <https://www.taaflo-tpafbo.com>. In all cases, the BSC invoice must reflect the following:
- (a) Total BSC/BAF for each BL on the invoice
 - (b) Total net weight of BL(s)
 - (c) Total cost of the BSC/BAF (cost of the SEAVAN based on size (i.e., 40 ft or 45 ft) or cost of the Breakbulk)
 - (d) Sail date
 - (e) Ocean Carrier Waybill or a web link to the Ocean Carrier website
 - (f) Total cu ft for each BL on the OBL/invoice
- (2) The Ocean Carrier Waybill or a web link to the Ocean Carrier website must be provided to JPPSO/PPSO so they can validate the BSC charge.
- (3) Computing Bunker Surcharge for SEAVAN:
- (a) Formula: Total BSC for SEAVAN ÷ Total cu ft used × cu ft used per shipment = individual shipment BSC.
 - (b) Example: Total cost of the BSC/BAF for the SEAVAN = \$1,030 USD, total cu ft used in the SEAVAN = 1,921 cu ft, total cu ft of each shipment = 591 and 1330.

BL#	Net Wt.	Gross Wt.	Cube	PCS	SCAC
AGFMXXXXXXXX	3,385	4,315	591	3 of 3	XXXX
HAFCXXXXXXXX	7,589	9,868	1,330	7 of 7	XXXX
	10,974	14,183	1,921	10	

- (c) Divide the total cost of the BSC/BAF for the SEAVAN by the total cu ft used in the SEAVAN to get the per cu ft cost ($\$1,030 \div 1921 = 0.536179$).
- (d) Multiply the cu ft of each shipment with the per cu ft cost:

$591 \times 0.536179 = \$316.88178$	\$316.88
$1330 \times 0.536179 = \$713.11807$	\$713.12
	\$1,030

- (4) Computing Bunker Surcharge for Breakbulk:
- (a) Formula: Cu ft cost (as identified on the Seaco or TPAFBO website) ÷ 40 = per cu ft cost × cu ft of shipment.
 - (b) Example: Cu ft cost = $\$14.40 \div 40 = \0.36 per cu ft × 357 cu ft of shipment = \$128.52 Breakbulk BSC.

Note: Please be advised, if the TSP's invoice amount does not match the PPSO's validation it may be subject to dispute or denial until the discrepancy has been resolved.

- c. **Port Congestion Surcharge (CON)** - An extra charge that is billed to the TSP for controlling the congestion of trucks/vessels entering/departing the port. This surcharge is applicable to codes of service 4 and 7. TSP must provide a copy of the invoice from the Port Authority (not a third-party provider or port agent) to the PPSO.

Note: Air fuel, Bunker, and Port Congestion (CON) surcharges are not applicable on shipment codes of service T and J.

Item 232 - TSP Representation

If the awarded TSP updates or changes either of the valid origin and destination shipping agent representative fields in DPS, an automated e-mail will be sent to the customer's designated e-mail account in the counseling module. TSPs that fail to maintain accurate representative data in DPS may be subject to administrative action.

Item 233 - Emergency Services

1. Notwithstanding any other provision of this Tender, TSPs may be requested to provide equipment, personnel, and services not described herein as may be required to accommodate surges to the Government's requirements.
2. These requirements may materialize in the event of a
 - a. declaration of war,
 - b. national emergency,
 - c. natural disaster, or
 - d. non-forecasted contingency of a military or humanitarian nature.
3. USTRANSCOM may, at any time, negotiate with TSPs to make changes in writing or orally (to be formalized in writing) to the work ordered that is within the general scope of this Tender, with compensation mutually agreed upon by USTRANSCOM and the TSPs involved. Changes may include, but are not limited to:
 - a. Terms and conditions of the International Tender (i.e., tonnage increases, extended Pickup and Delivery linehaul Service areas);
 - b. Method or manner of performance of the work, to include extending operating hours;
 - c. Acceleration in the performance of work.
4. Any other written or oral order from any source other than as directed by USTRANSCOM will not be considered valid until approved.
 - a. Such orders will be considered only after the TSP gives written notice stating the date and circumstances, and the source of the order.
 - b. The TSP may process the change, as set forth below, upon approval.
5. Except as provided in this provision, no order, statement, or conduct of any transportation official shall be treated as a change under this provision or entitle the TSP to an equitable adjustment. No proposal by the TSP for an equitable adjustment shall be allowed if asserted after final payment.

6. Linehaul and accessorial charges under this provision will be billed at the levels agreed upon under this item. All charges associated with shipments moving under this item must be accompanied by a detailed note within DPS containing the following statement: "These charges are in accordance with adjustments or negotiations for services authorized by USTRANSCOM" followed by the PP Advisory number.

Chapter 3 - Conditions, Rules, and TSP Administration Requirements

Purpose

This chapter contains terms, conditions, and rules, TSP administrative requirements and rules that the TSPs agree to adhere to for participation in the international program. By filing rates, TSPs verify they will adhere to the terms, conditions, rules, accessorial rates, and charges contained in this Tender.

Item 300 - Rate Filing Prerequisites

1. TSPs must have satisfied all administrative requirements IAW DoD Personal Property Program regulations, publications, and guidelines (e.g., DTR Part IV, Chapter 403, International Tender, and USTRANSCOM TSP Qualifications).
2. To see additional information on obtaining or expanding TSP approvals please visit <https://www.ustranscom.mil/dp3/pdfs.cfm>.

Item 301 - Reserved for Future Use

Item 302 - Criteria for Eligibility as Small Disadvantaged Business Concern for the Purpose of Transportation Service Acquisition

1. For the purpose of transportation service acquisition, the term "disadvantaged" refers to socially and economically disadvantaged individuals as defined below:
 - a. Socially disadvantaged individuals are those U.S. citizens who have been subjected to racial or ethnic prejudice or cultural bias because of their identity as a member of a group without regard to their individual qualities.
 - b. Economically disadvantaged individuals are those socially disadvantaged individuals whose ability to compete in the free enterprise system has been impaired due to diminished capital and credit opportunities as compared to others in the same line of business and competitive market area that are not socially disadvantaged.
 - c. Socially and economically disadvantaged individuals are defined as "Black Americans, Hispanic Americans, Native Americans (includes American Indians, Eskimos, Aleuts, and Native Hawaiians) Asian-Pacific Americans, and other minorities found to be disadvantaged by the Small Business Administration."
2. To qualify as a small, disadvantaged business, a concern must be a small business concern with at least 51 percent of the stock owned by one or more socially and economically disadvantaged individuals; or a publicly owned business with at least 51 percent of the stock owned by one or more such individuals. Management and daily business operations must be controlled by one or more socially and economically disadvantaged individuals.

Item 303 - Reserved for Future Use

Item 304 - Compensatory Rates

1. Rates submitted will be filed in compliance with the policies and procedures of this Tender.
 - a. TSPs should evaluate each rate filed to ensure that quality service can be provided at that rate.

- b. Rates will be filed only between those rate areas where the TSP desires to serve.
 - c. TSPs must provide service to the entire rate area and not just the area immediately surrounding the installation.
 - d. TSPs filing rates and refusing to serve the entire rate area may have their rates removed for the rate area.
2. USTRANSCOM may initiate set off action or seek recourse against surety for any increased expenditures to the Government, such as re-procurement costs for transportation services, resulting from a TSP failing to honor its rates.

Item 305 - 308 Reserved for Future Use**Item 309 - Intra-European Theater Rates**

1. USTRANSCOM may solicit rates for movement of containerized HHG.
2. When shipments move under the USTRANSCOM J9 Europe Tender, the low-rate setter will receive 100 percent of the containerized shipments. The cycle of this Tender begins 01 April and ends 31 March. PPSOs will compare the low containerized rate against other available methods to determine mode of shipment.
3. TSP's SFR submissions will include any anticipated currency fluctuations.
4. TSPs filing Code 8 rates for intra-theater movements are required to move shipments by air. TSPs must be prepared to provide a rated air waybill to support that the service was properly provided in accordance with the COS definitions in this Tender.

Item 310 - 311 Reserved for Future Use**Item 312 - Inter-Theater Code J and T Shipments**

1. The TSP will be responsible only for origin and destination services and delivery to and from the appropriate aerial port.
2. The Government will be responsible for routing between APOE in one theater and APOD in another theater.
3. The TSP's SFRs should not include CONUS overland transportation costs.

Item 313 - 316 Reserved for Future Use**Item 317 - Reporting Requirements**

1. Within, but not more than 14 calendar days following the date of pickup of a shipment, the TSP will provide the following information (to include updates when information changes) in DPS:
 - a. Estimated date the shipment will be picked up by linehaul equipment for movement to the ocean or aerial port.
 - b. Estimated date of sailing and identity of port and vessel (Code 4/7).
 - c. Routing of vessel and discharge port (Code 4/7).
 - d. Estimated date of arrival at destination (Code 4/7).

Item 318 - Reserved for Future Use**Item 319 - Delivery to Storage In Government Facilities**

1. When a shipment is delivered to non-temporary storage in a government facility, the facility is considered the final destination. Further movement of the shipment will be made under a separate BL/invoice.
2. The Government reserves the right to award the contract for transportation of any lot of personal property stored with a NTS TSP to any TSP the Government may select according to the DTR business rules. The NTS TSP shall promptly, and in accordance with the direction of the appropriate TO, make lots available to the receiving TSP for Carriage on a properly protected loading area of the NTS TSP in a condition satisfactory to be received by such TSP for Carriage.
3. The NTS TSP shall unstuff the container and permit any such TSP for Carriage to inventory and load property from its facility without any charge to the receiving TSP for Carriage or additional charge to the Government not already in the NTS Tender and will acknowledge the receiving TSP's notation of damage or shortage by signing the receiving TSP's exception sheet or rider, noting the damages and/or shortages, or by allowing the receiving TSP's representative to note damages and/or shortages on the NTS TSP's inventory form.
4. The NTS TSP is obligated to repack, at no cost to the Government, any carton refused by the TSP due to improper packing which has been verified by the TO, or their representative.
5. When a shipment pickup address is an NTS facility and the TSP missed the pickup date as a result requiring the NTS TSP to continue storage and liability for the property, the NTS TSP will be compensated for continued storage on the shipment.
 - a. Communication: The NTS TSP is not required to stay open after 5 p.m. All services (e.g., rider, inspection, loading, etc.) must be completed before closing, unless otherwise agreed to by the NTS TSP. To best facilitate this, the TSP must coordinate a pickup date and time with the NTS TSP, allowing enough to time to perform all services.
 - b. Failure by NTS TSP to Prepare Lot: In the event a NTS TSP fails to prepare a lot (either partial or full) for pickup by the TSP on the agreed date, the TO will advise the USTRANSCOM Storage Management Office (SMO) at transcom.scott.tcj9.mbx.pp-smo@mail.mil. Prior to determining fault or initiating payment, the PPSO/PPPO must contact the SMO. The SMO will make a final determination against the NTS TSP for possible extra charges attributed to the NTS TSP for not preparing storage lot as ordered. If work does not commence within 1 hour of free waiting time the TSP will be paid waiting time (reference Item 503). After the PPSO has determined the cost of waiting time, the PPSO will advise the NTS TSP of the refund amount. The NTS TSP will refund the amount stating, "Waiting time for delay in preparing NTSR lot."
 - c. Missed Pickup by TSP: In the event the TSP does not pick up the lot on the specified date, between the hours of 8 a.m. and 5 p.m., the NTS TSP shall notify the TO and continue to store, protect and be responsible for the property. If NTS TSPs do not re-handle the property, or if it's determined that the property did or could remain staged, they should not be compensated for re-handling. The TO should coordinate with the SMO at transcom.scott.tcj9.mbx.pp-smo@mail.mil if they have questions about re-handling. Appropriate compensation will be made for putting the shipment back into

storage, upon approval of the TO. The DD Form 1164 will be amended and/or reissued to authorize the additional cost and document the TSP failure as the cause of the additional cost. Further, the PPSO will initiate set-off action against the TSP on the applicable BL through DPS for additional charges (e.g., handling in, etc.) attributed to the TSP for not picking up the storage lot as scheduled. After the PPSO has received the cost for re-handling from the NTS TSP, the PPSO will advise the TSP of the refund amount. The TSP will refund the amount in DPS on the same invoice they submit for origin services using Item Code 533A with a note stating "NTSR missed PU refund fees."

Item 320 - TSP Agent/Port Agent Facilities

1. TSPs must guarantee USTRANSCOM free access to agent/port agent's facilities during normal working hours. This must be reduced to a written binding agreement between the TSP and its agent.
2. HQ SDDC port operators or official representatives will randomly inspect the condition of TSP containers at these facilities.
 - a. Data will be provided on both inbound and outbound shipments.
 - (1) Containers found to be in a condition rendering the container unacceptable for continued movement of the contents; will be identified to the concerned TSP and/or agent for immediate corrective action.
 - (2) Unacceptable conditions would include damaged or poorly constructed containers; illegible, improper, or nonexistent markings; improper waterproofing, or other such violations.
 - (3) The agent/port agent of the TSP must immediately arrange to have the container restored to an acceptable condition or, alternatively, must repack the shipment in an acceptable container prior to onward movement.
 - (4) TSPs failing to take corrective action may be immediately placed in non-use by USTRANSCOM and the shipment may be terminated by the Government.
 - (5) Any additional Government expenses may be set off against the TSP's BL.
3. In addition to the condition of containers, the USTRANSCOM representatives will observe general warehousing practices, such as:
 - a. housekeeping practices (e.g., floor free of debris),
 - b. staging in proximity to hazardous materials,
 - c. an overall impression of orderliness and condition of building; and
 - d. protection of property from the elements and adequate security.
4. In accordance with Section 453 of Title 37, United States Code, no TSP, port agent, warehouseman, freight forwarder, or other person involved in the transportation of property may have any lien on, or hold, impound, or otherwise interfere with, the movement of baggage and HHGs being transported under this section.
 - a. Accordingly, TSPs agree to include the following stipulation in their contracts, agreements, and/or orders with underlying TSPs/agents:

- (1) "By acceptance of this contract/agreement/order/reimbursement schedule, I recognize the property being transported hereunder is United States DoD-sponsored personal property and, as such, will not be detained by my firm under any circumstances. Further, I guarantee the Government free access to any facilities, including those of my agents, during normal working hours, for their lawful purpose of inspecting and removing TSP containers in which DoD-sponsored personal property is shipped."
- b. Agents refusing to consummate agreements/contracts containing this clause will not be used by TSPs.

Item 321 - Right to Audit by DoD

1. By filing rates, the TSP agrees USTRANSCOM, or other appropriate Government agencies, shall have audit and inspection rights for any purposes described as follows:
 - a. Costs: The right to examine TSP Financial Records, documents, and other evidence (collectively Financial Records) including accounting procedures and practices, sufficient to reflect all direct and indirect costs of whatever nature claimed to have been incurred and anticipated to be incurred for the performance of this service. These Financial Records will be provided by the TSP at no additional cost to the Government. SFR submitted by TSPs will include cost associated with these audits and the submission of these Financial Records. Such right of examination shall include inspection at a reasonable time, at the TSP's place of business, or such parts thereof, as may be engaged in the performance of the solicitation.
 - b. Cost Data Elements: If the TSP submits cost or pricing data in connection with the prices offered in the Tender or any change or modification thereto, USTRANSCOM, or its designated Government representatives, shall have the right to examine all financial records, documents, and other such TSP data related to the pricing or performance of such service, change, or modification, for the purpose of evaluating the accuracy, completeness, and reasonableness of the costs or pricing data submitted. The right of examination shall extend to all documents necessary to permit adequate evaluation, along with the computations and/or projections used therein.

Item 322 - Right to Audit by Comptroller General

1. The Comptroller General of the United States or its designated Government representatives may have access to and the right to directly examine pertinent books, papers, documents, and records (collectively "Financial Records") of the TSP involving transactions related to the Tender for any lawful purpose until 3 years after final payment of any BL under these rates.
2. These Financial Records will be provided by the TSP at no additional cost to the Government. SFR submitted by TSPs will include cost associated with these audits and the submission of these Financial Records.
3. The periods of access and examination of records relating to litigation or settlement of claims arising from the performance of the TSP, or costs and expenses of these rates to which exception has been taken by the Comptroller General or its representatives, shall continue until such appeals, litigation, or claims have been settled.

Item 323 - Intra-Theater Tenders

Intra-theater tenders will not be utilized for over ocean transportation to/from ports within CONUS or moving within an overseas theater unless prior approval is provided, this approval would be granted on a case-by-case basis for emergency services only. (Exception: Currently, there are no intra-theater Pacific rates at this time).

Item 324 - Required Numbers

1. Toll Free Number (For Customer Use Only)
 - a. TSP agrees to provide a toll-free number for customer inquiries and problem resolution during any phase of the move. If toll free capability is not available, the TSP shall accept collect calls.
 - b. The number shall be operational 24 hours a day, 7 days a week.
 - c. However, as a minimum, it must be manned during normal business hours for the area in which the toll-free number is established.
 - d. A type of recorder, beeper, answering service, Internet e-mail capability or other electronic device may be used for hours other than specified.
 - e. Knowledgeable personnel representing the TSP must acknowledge and respond to the customer's concerns within 24 hours from the customer's initial call if received Monday through Friday and by close of business the following workday for calls/inquires received by the TSP on Saturdays, Sundays, or legal (officially declared national) holidays.
 - f. The TSP is required to provide to the customer the toll-free number and other means of contact information by the shipment pickup date. The TSP may furnish this information to the customer directly or through their local agent. This provision is an independent requirement; therefore, any cost associated with this requirement shall be included as part of the TSP's proposed rates.
2. Facsimile Number and e-mail Address
 - a. Each TSP will maintain a facsimile number and e-mail address for purposes of tracings, shipment notification of changes, etc.
 - b. USTRANSCOM will be notified immediately of any change in number.

Item 325 - Shipment Terminations

1. The Government reserves the right to terminate shipments at any point during transportation prior to delivery and to separately arrange for onward movement to destination under the following conditions:
 - a. A shipment becomes frustrated at the facility of an origin/destination agent or port agent due to:
 - (1) Nonpayment of charges by the TSP, whereby the shipment is being detained by the ocean or motor TSP either aboard a vessel or within an ocean or motor terminal.
 - (2) Nonpayment of port agent's fees and/or charges by a TSP, whereby the shipment is being detained at a port agent's facility by a port agent.

- (3) Detention of a shipment by an origin/destination local agent for any reason relative to TSP/agent disputes.
 - (4) Non-traceable or unavailable documentation attributable to the fault of the TSP or its agents.
 - (5) Port congestion arising from the inability of the port agent and/or TSP to book and clear shipments in a timely manner.
 - b. The TSP is unable to perform in such a manner as to ensure the timely movement of the shipment.
 - c. In any of the above or similar instances whereby the TSP cannot meet performance standards, the Government may
 - (1) terminate the shipment,
 - (2) obtain release of the shipment from the agent, port agent, ocean, or motor TSP, as applicable, and
 - (3) at its option, pay any charges necessary to release the shipment, and initiate action for setoff of expenses incurred by the Government in excess to those which would have been incurred if the TSP had maintained total through movement of the shipment.
 - d. The TSP will be paid up to the point of termination in accordance with rates and charges contained in this Tender.
 - e. Original TSP's containers will be made available to original TSP by the new TSP at destination.
 - f. In the case of port agents, all DoD HHG and UB shipments must be identified on OBL/manifests as DoD-sponsored property subject to release to DoD upon demand. This will be reduced to a written binding agreement between the TSP and its agent.
2. Detailed procedures for processing frustrated shipments are contained in DoD 4500.9-R, Part IV.

Item 326 - Excess Cost

To enable DoD to collect excess costs incurred due to TSPs/forwarders defaulting on shipments contained in the pipeline, TSPs assuming the onward movement will maintain records of all excess costs including demurrage, storage, etc., over and above those normally associated with a shipment. TSPs will report such costs to USTRANSCOM, ATTN: J9, for further notification to the finance centers and the General Services Administration (GSA).

Item 327 - 329 Reserved for Future Use

Item 330 - Intra-Theater Pacific Rates

1. Code T HHG originating at Australian APOEs for Pacific intra-theater movement should not transit CONUS. Shipment will be routed to Hickam AFB, HI, for onward movement to the destination APOD, via AMC airlift.
2. Shipments short loaded at CONUS ports, will be moved via AMC opportune airlift or via surface transportation at TWCF (Transportation Working Capital Fund) expense.

3. When TSP is required to move a shipment between CONUS ports, compensation will be made under provisions of Item 528, Use of Alternate Ports COS T shipments.

Item 331 - 332 Reserved for Future Use**Item 333 – Packing Privately Owned Firearms (POFs)**

1. All privately-owned firearms (POFs) will be placed in a number one (1) external shipping container and positioned so that they are readily accessible for examination by customs officials, when required, and the container closed at customer's residence.
2. TSPs must comply with the following provisions of Public Law 103-159, Brady Handgun Violence Protection Act, and the Personal Property Consignment Instruction Guide (PPCIG).
 - a. Marking the outside of any package, luggage, or other container indicating that the package contains a firearm is prohibited. This does not exclude attaching documentation in a sealed envelope to a box/container of HHGs.
3. Written acknowledgement of receipt from the recipient of any package containing a firearm is required. Signatures can be on a bill of lading, inventory, or TSP-generated receipt. Signatures are only required at the time of delivery, (i.e., not required at in transit points as shipments move between TSPs and agents).

Item 334 - 335 Reserved for Future Use

Chapter 4 - Claims and Liability

Purpose

This section pertains to the claims process and TSP Liability on International shipments.

Item 400 - Claims

TSPs agree to the Claims and Liability Business Rules which are located at <https://www.ustranscom.mil/dp3/pdfs.cfm>.

Item 401 - Reserved for Future Use

Item 402 - Collection of Freight Charges on HHG Shipments Involving Loss or Destruction in Transit and on Shipments Transported

The collection of unearned freight charges under this item is not applicable to shipments in which the TSP has paid Full Replacement Value (FRV) under 10 USC 2636a on claims for loss or destruction in an amount less than or equal to the TSP maximum liability set forth by this Tender.

Chapter 5 - Schedule of Rates and Charges

Purpose

This section provides rates and charges for shipments moving under this Tender.

General Requirements and Conditions

1. Commodity or Service: HHG: COS 4, 6, & T UB: COS 7, 8, & J
2. Assignment of Bills: Except for assignment of payment of my original bills to a bank, factor, or other financial institution for collection, TSPs will not subrogate their rights and/or interest in the bills for service rates and charges on which such charges are based, or any subsequent claims thereon to third parties, unless the subrogation is revocable and under TSP's control.
3. When circumstances beyond the control of the TSP or Government prevent the TSP/agent from performing services under normal means, special provisions will be authorized to continue movement of property.

General Price Adjustment (GPA)

1. This item provides for the mechanism by which USTRANSCOM may choose to apply an adjustment, effective with the new annual rate cycle, to the rates and charges contained in this Tender based on the application of certain Government cost indices. The following items are not subject to GPA, however decisions on whether to apply the GPA will be evaluated annually:
 - a. Item Codes:
 - (1) 505A
 - (2) 505B
 - (3) 508A
 - (4) 508B
 - (5) 508C
 - b. OCONUS Rates.
2. A periodic GPA may apply on all rates and charges named in this Tender as provided herein. The GPA calculations will be performed by USTRANSCOM based on an annual review of U.S. Department of Labor indices. USTRANSCOM will announce in this Tender whether adjustments will be applied, allowing TSPs time to adjust rates as needed prior to DPS Rate Filing. If a GPA adjustment is made, it will be incorporated into the International Tender and tables and will be effective on May 15th of each year (e.g., May 15th, 2022).
 - a. Applicable U.S. Department of Labor indices are as reported on the Bureau of Labor Statistics <http://data.bls.gov/cgi-bin/srgate> website, as follows:
 - (1) Consumer Price Index (CPI) information is based on All Urban Consumers, Not seasonally adjusted, U.S. City Average, for all Items (less Food and Energy), Series ID cuur0000SA0L1E.

- (2) Current Employment/Unemployment Index (CEU) information is based on the average hourly earnings of production workers in the National Employment Index for Hours and Earnings, Not seasonally adjusted, for Transportation and Warehousing, specialized freight trucking, under NAICS Code 4842, Series ID ceu4348420008.
- b. GPA will be based on the increase in the CEU times .41 (representing the labor portion of carriers' expenses) plus the increase in the CPI times .59 (representing the reciprocal of .41), as specified in paragraph 2.c.
- c. To determine the GPA to apply, USTRANSCOM will
 - (1) determine the unadjusted indexes for each index (CPI and CEU) applicable at the beginning and at end of the specified 12 month basing period (e.g., July to July),
 - (2) determine the percentage increase in the CEU, subtract the ending CEU from the beginning CEU and divide that answer by the beginning CEU, and then multiply that answers times .41,
 - (3) determine the percentage increase in the CPI, subtract the ending CPI from the beginning CPI and divide that answer by the beginning CPI, then multiply that answer times .59, and
 - (4) add the two weighted subtotals together to determine the GPA percentage increase/decrease that may apply.
- d. The GPA and background calculations will be rounded to the 9th decimal place. All final costs will be rounded to the 2nd decimal place (i.e., background data is \$1.245343423, will round in the International Tender and tables as \$1.25).
- e. Notwithstanding any other provisions of this Tender, the GPA will not apply to the provisions of third-party charges and valuation, or other areas determined by USTRANSCOM.

Example: (X = index number to be determined as provided herein):

	July	to	July	% Change	times	Factor	=	GPA
CPI =	X		X	X		.59	=	X
CEU =	X		X	X		.41	=	X
GPA Total = X.XXXXXXXXXX GPA								

Item 500 - Additional Services

- 1. Rates and schedules shown apply in dollars and cents per hundredweights (cwt) for services performed in the counties named per designated GBLOC.
 - a. Example 1: Services performed at Autauga County, AL:

Under the state listing for Alabama, Autauga County is shown under the installation of JPPSO-SC, San Antonio, TX. All rates and schedules opposite JPPSO-SC, San Antonio, TX apply for services performed in Autauga County. (The same rates and schedules would also apply when services are performed in Baldwin, Bullock, Butler, etc. and the other Alabama Counties named under JPPSO-SC, San Antonio, TX.)

b. Example 2: Services performed at Baker County, Georgia:

Under the state listing for Georgia, Baker County is shown under the installation of JPPSO-SE, Jacksonville, FL. All rates and schedules opposite JPPSO-SE, Jacksonville, FL apply for services performed in Baker County. (The same rates and schedules would also apply when services are performed in Banks, Barrow, Bartow, etc. and the other Georgia Counties named under JPPSO-SE, Jacksonville, FL.)

2. The rates and schedules aligned with the Services designated DoD Installation and associated GBLOC will apply for services performed in any of the counties named for the DoD installations.

State GBLOC Item 500 Table

Item 502 Labor Reg	Item 502 Labor O/T	Item 532 Long Carry	Item 518 SIT 1st Day & W/H	Item 518 SIT Ea. Addt'l Day	Item 520 SIT P/D Schedules
502A	502B	532A	518B	518A	520A

ALABAMA						
Fleet Logistics Center, Jacksonville, FL (CNNQ)	25.80	32.89	1.33	7.64	0.17	F
Barbour, Bibb, Blount, Calhoun, Chambers, Cherokee, Choctaw, Clay, Cleburne, Coffee, Colbert, Covington, Cullman, Dale, DeKalb, Etowah, Fayette, Franklin, Geneva, Greene, Hale, Henry, Houston, Jackson, Jefferson, Lamar, Lauderdale, Lawrence, Lee, Limestone, Madison, Marengo, Marion, Marshall, Morgan, Pickens, Pike, Randolph, Russell, Saint Clair, Shelby, Sumter, Talladega, Tuscaloosa, Walker, Winston						
JPPSO-SC, San Antonio, TX (HAFC)	18.41	24.00	0.79	7.42	0.17	D
Autauga, Baldwin, Bullock, Butler, Chilton, Clarke, Conecuh, Coosa, Crenshaw, Dallas, Elmore, Escambia, Lowndes, Macon, Mobile, Monroe, Montgomery, Perry, Tallapoosa, Washington, Wilcox						

ARIZONA						
JPPSO-NC, Colorado Springs, CO (KKFA)	28.20	40.38	1.33	8.27	0.18	G
Apache, Coconino, Gila, Graham, Greenlee, Maricopa, Mohave, Navajo, Pima, Pinal, Yavapai						
Fleet Logistics Center, San Diego, CA (LKNQ)	28.12	40.14	1.33	7.81	0.15	G
Cochise, La Paz, Santa Cruz, Yuma						

ARKANSAS						
Fleet Logistics Center, Norfolk, VA (CNNQ)	20.15	26.73	0.79	6.25	0.15	E
Crittenden, Cross, Lee, Monroe, Phillips, Saint Francis, Woodruff						
JPPSO-SC, San Antonio, TX (HAFC)	28.76	36.18	0.79	5.86	0.15	E
Arkansas, Ashley, Baxter, Bradley, Calhoun, Chicot, Clark, Clay, Cleburne, Cleveland, Columbia, Conway, Craighead, Dallas, Desha, Drew, Faulkner, Fulton, Garland, Grant, Greene, Hempstead, Hot Spring, Howard, Independence, IZard, Jackson, Jefferson, Lafayette, Lawrence, Lincoln, Little River, Lonoke, Marion, Miller, Mississippi, Nevada, Ouachita, Perry, Pike, Poinsett, Prairie, Pulaski, Randolph, Saline, Searcy, Sevier, Sharp, Stone, Van Buren, Union, White						
JPPSO-NW, JB Lewis-McChord, WA (JEAT)	28.76	35.85	1.33	6.58	0.15	F
Benton, Boone, Carroll, Crawford, Franklin, Johnson, Logan, Madison, Montgomery, Newton, Polk, Pope, Scott, Sebastian, Washington, Yell						

Item 502 Labor Reg	Item 502 Labor O/T	Item 532 Long Carry	Item 518 SIT 1st Day & W/H	Item 518 SIT Ea. Addt'l Day	Item 520 SIT P/D Schedules
502A	502B	532A	518B	518A	520A

CALIFORNIA						
JPPSO-NC, Colorado Springs, CO (KKFA)	50.82	70.56	1.65	12.37	0.21	P
Alpine, Amador, Butte, Calaveras, Colusa, Del Norte, El Dorado, Glenn, Humboldt, Kern (excluding Cities of Inyokern, Johannesburg, Randsburg, Ridgecrest, Saltdale), Lake, Lassen, Los Angeles (Cities of Elizabeth Lake, Hi Vista, Lake Hughes, Lancaster, Leona Valley, Littlerock, Palmdale, Pearlblossom, Quartz Hill) Madera, Mariposa, Mendocino, Merced, Modoc, Mono, Napa, Nevada, Placer, Plumas, Sacramento, San Joaquin, San Luis Obispo, Santa Barbara, Shasta, Sierra, Siskiyou, Solano, Stanislaus, Sutter, Tehama, Trinity, Tuolumne, Yolo, Yuba						
Integrated Support Command, Alameda, CA (LHNQ)	50.82	70.56	1.65	12.40	0.21	P
Alameda, Contra Costa, Marin, San Francisco, San Mateo, Santa Clara, Sonoma						
Fleet Logistics Center, San Diego, CA (LKNQ)	50.82	70.56	1.65	11.54	0.21	P
Fresno, Imperial, Inyo, Kern (Cities of: Gorman, Inyokern, Johannesburg, Pearsonville, Randsburg, Ridgecrest, and Saltdale), Kings, Los Angeles (except cities shown for JPPSO-NC (KKFA)), Monterey, Orange, Riverside, San Benito, San Bernardino, Santa Cruz, San Diego, Tulare, Ventura NOTE: Shipments for members assigned to Naval Postgraduate School, Fleet Numerical Meteorology & Oceanography Center and Coast Guard Station Monterey.						

COLORADO						
JPPSO-NC, Colorado Springs, CO (KKFA)	40.78	61.19	1.65	11.42	0.17	J
Adams, Alamosa, Arapahoe, Archuleta, Baca, Bent, Boulder, Broomfield, Chaffee, Cheyenne, Clear Creek, Conejos, Costilla, Crowley, Custer, Delta, Denver, Dolores, Douglas, Eagle, El Paso, Elbert, Fremont, Garfield, Gilpin, Grand, Gunnison, Hinsdale, Huerfano, Jackson, Jefferson, Kiowa, Kit Carson, La Plata, Lake, Larimer, Las Animas, Lincoln, Logan, Mesa, Mineral, Moffat, Montezuma, Montrose, Morgan, Otero, Ouray, Park, Phillips, Pitkin, Prowers, Pueblo, Rio Blanco, Rio Grande, Routt, Saguache, San Juan, San Miguel, Sedgwick, Summit, Teller, Washington, Weld, Yuma						

CONNECTICUT						
JPPSO-NE, Chelmsford, MA (AGFM)	37.65	49.91	0.94	9.54	0.18	L
Hartford, Litchfield, Middlesex, New Haven, New London, Tolland, Windham						
JPPSO-Mid Atlantic, Fort Belvoir, VA (BGAC)	42.42	56.91	1.65	12.02	0.22	O
Fairfield						

DELAWARE						
JPPSO-NE, Chelmsford, MA (AGFM)	36.67	45.14	0.94	8.64	0.17	I
Kent, New Castle, Sussex						

DISTRICT OF COLUMBIA						
JPPSO Mid Atlantic, Fort Belvoir, VA (BGAC)	31.01	40.61	0.79	7.92	0.17	J
District of Columbia						

FLORIDA						
Seventh CG District Office, Miami, FL (CLPK)	28.20	33.80	0.79	6.69	0.17	F
Broward, Collier, Hendry, Lee, Miami-Dade, Palm Beach						
JPPSO-SE, Jacksonville, FL (CNNQ) US49	27.39	35.45	1.33	7.26	0.15	D
Alachua, Baker, Bradford, Clay, Columbia, Dixie, Duval, Escambia, Flagler, Gilchrist, Levy, Marion, Nassau, Putnam, Saint Johns, Santa Rosa, Union						
JPPSO-SE, Jacksonville, FL (CQNL) US4965500	18.37	23.94	0.79	5.79	0.15	C
Monroe (Including Keys)						
JPPSO-SC, San Antonio, TX (HAFC)	27.39	35.45	1.33	8.91	0.17	F
Bay, Brevard, Calhoun, Charlotte, Citrus, De Soto, Franklin, Gadsden, Glades, Gulf, Hamilton, Hardee, Hernando, Highlands, Hillsborough, Holmes, Indian River, Jackson, Jefferson, Lafayette, Lake, Leon, Liberty, Madison, Manatee, Martin, Okaloosa, Okeechobee, Orange, Osceola, Pasco, Pinellas, Polk, Saint Lucie, Sarasota, Seminole, Sumter, Suwannee, Taylor, Volusia, Wakulla, Walton, Washington						

Item 502 Labor Reg	Item 502 Labor O/T	Item 532 Long Carry	Item 518 SIT 1st Day & W/H	Item 518 SIT Ea. Addt'l Day	Item 520 SIT P/D Schedules
502A	502B	532A	518B	518A	520A

GEORGIA						
JPPSO-SE, Jacksonville, FL (CNNQ)	28.76	38.09	1.65	8.16	0.18	E
Appling, Bacon, Baker, Banks, Barrow, Bartow, Brantley, Bryan, Bulloch, Burke, Calhoun, Camden, Candler, Carroll, Catoosa, Charlton, Chatham, Chattahoochee, Chattooga, Cherokee, Clarke (All Branches of Service), Clay, Clayton, Cobb, Columbia, Coweta, Crisp, Dade, Dawson, Decatur, DeKalb, Dougherty, Douglas, Early, Effingham, Elbert, Emanuel, Evans, Fannin, Fayette, Floyd, Forsyth, Franklin, Fulton, Gilmer, Glascock, Glynn, Gordon, Grady, Greene, Gwinnett, Habersham, Hall, Haralson, Hart, Heard, Henry, Jackson, Jeff Davis, Harris, Jefferson, Jenkins, Lee, Liberty, Lincoln, Long, Lumpkin, Madison, Marion, McDuffie, McIntosh, Meriwether, Miller, Mitchell, Morgan, Murray, Muscogee, Newton, Oconee, Oglethorpe, Paulding, Pickens, Pierce, Polk, Quitman, Rabun, Randolph, Richmond, Rockdale, Schley, Screven, Seminole, Spalding, Stewart, Stephens, Sumter, Talbot, Taliaferro, Tattall, Taylor, Terrell, Troup, Toombs, Towns, Turner, Union, Walker, Walton, Warren, Wayne, Webster, White, Whitfield, Wilkes, Worth						
JPPSO-SC, San Antonio, TX (HAFC)	18.41	24.00	0.79	5.39	0.15	A
Atkinson, Baldwin, Bibb, Bin Hill, Berrien, Bleckley, Brooks, Butts, Clinch, Coffee, Colquitt, Cook, Crawford, Dodge, Dooly, Echols, Hancock, Houston, Irwin, Jasper, Johnson, Jones, Lamar, Lanier, Laurens, Lowndes, Macon, Monroe, Montgomery, Peach, Pike, Pulaski, Putnam, Telfair, Thomas, Tift, Treutlen, Twiggs, Upson, Ware, Washington, Wheeler, Wilcox, Wilkinson						

IDAHO						
JPPSO-NC, Colorado Springs, CO (KKFA)	32.35	43.84	1.65	8.98	0.17	H
Ada, Adams, Bannock, Bear Lake, Benewah, Bingham, Blaine, Boise, Bonner, Bonneville, Boundary, Butte, Camas, Canyon, Caribou, Cassia, Clark, Clearwater, Custer, Elmore, Franklin, Fremont, Gem, Gooding, Idaho, Kootenai, Jefferson, Jerome, Latah, Lemhi, Lewis, Lincoln, Madison, Minidoka, Nez Perce, Oneida, Owyhee, Payette, Power, Shoshone, Teton, Twin Falls, Valley, Washington						

ILLINOIS						
JPPSO-NE, Chelmsford, MA (AGFM)	61.19	77.44	1.65	12.34	0.22	Q
Adams, Alexander, Bartholomew, Bond, Brown, Calhoun, Carroll, Cass, Champaign, Christian, Clark, Clay, Clinton, Coles, Crawford, Cumberland, Daviess, De Witt, Douglas, Dubois, Edgar, Effingham, Fayette, Floyd, Ford, Franklin, Fulton, Gallatin, Gibson, Greene, Hamilton, Hancock, Hardin, Harrison, Henderson, Henry, Iroquois, Jackson, Jefferson, Jennings, Jersey, Jo Davies, Johnson, Kankakee, Knox, Lawrence, Livingston, Logan, McDonough, McLean, Macon, Macoupin, Madison, Marion, Martin, Marshall, Mason, Massac, Menard, Mercer, Monroe, Montgomery, Morgan, Moultrie, Ohio, Orange, Owen, Peoria, Perry, Piatt, Pike, Pope, Posey, Pulaski, Randolph, Rock Island, Saint Clair, Saline, Sangamon, Schuyler, Scott, Shelby, Spencer, Stark, Stephenson, Sullivan, Switzerland, Tazewell, Union, Vanderburgh, Vermillion, Vigo, Warren, Warrick, Washington, Wayne, White, Whiteside, Williamson, Woodford						
Fleet Logistics Center, Norfolk, VA (BGNC)	61.19	77.44	1.65	12.34	0.22	Q
Boone, Bureau, Cook, Crawford, De Kalb, Du Page, Edwards, Grundy, Jasper, Kane, Kendall, Lake, La Salle, Lawrence, Lee, McHenry, Ogle, Putnam, Richland, Wabash, Will, Winnebago						

INDIANA						
JPPSO-NE, Chelmsford MA (AGFM)	35.45	53.39	1.33	10.01	0.18	J
Adams, Allen, Benton, Blackford, Boone, Carroll, Cass, Clinton, De Kalb, Dearborn, Decatur, Delaware, Elkhart, Fayette, Fountain, Franklin, Fulton, Grant, Hamilton, Hancock, Hendricks, Henry, Howard, Huntington, Jasper, Jay, Johnson, Kosciusko, Lagrange, Lake, La Porte, Madison, Marion, Marshall, Miami, Montgomery, Morgan, Newton, Noble, Parke, Porter, Pulaski, Putnam, Randolph, Ripley, Rush, St. Joseph, Shelby, Starke, Steuben, Tippecanoe, Tipton, Union, Vermillion, Wabash, Warren, Wayne, Wells, White, Whitley						
Fleet Logistics Center, Norfolk, VA (BGNC)	61.17	77.44	1.33	12.34	0.22	Q
Bartholomew, Brown, Clark, Clay, Crawford, Daviess, Dubois, Floyd, Gibson, Greene, Harrison, Jackson, Jefferson, Jennings, Knox, Lawrence, Lake, La Porte, Martin, Monroe, Ohio, Orange, Owen, Perry, Pike, Porter, Posey, Scott, Spencer, Sullivan, Switzerland, Vanderburgh, Vigo, Warrick, Washington						

Item 502 Labor Reg	Item 502 Labor O/T	Item 532 Long Carry	Item 518 SIT 1st Day & W/H	Item 518 SIT Ea. Addt'l Day	Item 520 SIT P/D Schedules
502A	502B	532A	518B	518A	520A

IOWA						
JPPSO-NE, Chelmsford, MA (AGFM)	46.14	63.91	1.65	9.93	0.17	J
Allamakee, Appanoose, Benton, Black Hawk, Bremer, Buchanan, Butler, Cedar, Cerro Gordo, Chickasaw, Clayton, Clinton, Davis, Delaware, Des Moines, Dubuque, Fayette, Floyd, Franklin, Grundy, Hardin, Henry, Howard, Iowa, Jackson, Jasper, Jefferson, Johnson, Jones, Keokuk, Lee, Linn, Louisa, Lucas, Mahaska, Marion, Marshall, Mitchell, Monroe, Muscatine, Poweshiek, Scott, Tama, Van Buren, Wapello, Washington, Wayne, Winneshiek, Worth						
JPPSO-NC, Colorado Springs, CO (KKFA)	43.84	63.57	1.65	9.33	0.17	J
Adair, Adams, Audubon, Boone, Buena Vista, Calhoun, Carroll, Cass, Cherokee, Clarke, Clay, Crawford, Dallas, Decatur, Dickinson, Emmet, Fremont, Greene, Guthrie, Hamilton, Hancock, Harrison, Humboldt, Ida, Kossuth, Lyon, Madison, Mills, Monona, Montgomery, O'Brien, Osceola, Page, Palo Alto, Plymouth, Pocahontas, Polk, Pottawattamie, Ringgold, Sac, Shelby, Sioux, Story, Taylor, Union, Warren, Webster, Winnebago, Woodbury, Wright						

KANSAS						
JPPSO-NW, JB Lewis-McChord, WA (JEAT)	45.14	59.95	1.65	9.14	0.17	I
Anderson, Atchison, Brown, Clay, Cloud, Coffey, Dickinson, Doniphan, Douglas, Ellis, Ellsworth, Franklin, Geary, Graham, Jackson, Jefferson, Jewell, Johnson, Leavenworth, Lincoln, Linn, Lyon, Marshall, Miami, Mitchell, Morris, Nemaha, Norton, Osage, Osborne, Ottawa, Phillips, Pottawatomie, Republic, Riley, Rooks, Russell, Saline, Shawnee, Smith, Trego, Wabaunsee, Washington, Wyandotte						
JPPSO-NC, Colorado Springs, CO (KKFA)	22.62	33.88	0.79	6.31	0.15	C
Allen, Barber, Barton, Bourbon, Butler, Chase, Chautauqua, Cherokee, Cheyenne, Clark, Comanche, Cowley, Crawford, Decatur, Edwards, Elk, Finney, Ford, Gove, Grant, Gray, Greeley, Greenwood, Hamilton, Harper, Harvey, Haskell, Hodgeman, Kearny, Kingman, Kiowa, Labelle, Lane, Logan, McPherson, Marion, Meade, Montgomery, Morton, Neosho, Ness, Pawnee, Pratt, Rawlins, Reno, Rice, Rush, Scott, Sedgwick, Seward, Sheridan, Sherman, Stafford, Sumner, Stanton, Stevens, Thomas, Wallace, Wichita, Wilson, Woodson						

KENTUCKY						
JPPSO Mid-Atlantic, VA (BGAC)	25.58	33.55	1.33	7.38	0.15	D
Adair, Allen, Ballard, Barren, Breckinridge, Bullitt, Butler, Caldwell, Calloway, Carlisle, Carroll, Casey, Christian, Clinton, Crittenden, Cumberland, Daviess, Edmonson, Fulton, Graves, Grayson, Green, Hancock, Hardin, Hart, Henderson, Henry, Hickman, Hopkins, Jefferson, Larue, Livingston, Logan, Lyon, Marion, Marshall, McCracken, McLean, Meade, Metcalf, Monroe, Muhlenberg, Nelson, Ohio, Oldham, Russell, Shelby, Simpson, Spencer, Taylor, Todd, Trigg, Trimble, Union, Webster, Warren, Washington, Wayne						
JPPSO-NC, Colorado Springs, CO (KKFA)	35.45	53.04	0.94	10.01	0.18	J
Anderson, Bath, Bell, Boone, Bourbon, Boyd, Boyle, Bracken, Breathitt, Campbell, Carter, Clark, Clay, Elliott, Estill, Fayette, Fleming, Floyd, Franklin, Gallatin, Garrard, Grant, Greenup, Harlan, Harrison, Jackson, Jessamine, Johnson, Kenton, Knott, Knox, Laurel, Lawrence, Lee, Leslie, Letcher, Lewis, Lincoln, McCreary, Madison, Magoffin, Martin, Mason, Menifee, Mercer, Montgomery, Morgan, Nicholas, Owen, Owsley, Pendleton, Perry, Pike, Powell, Pulaski, Robertson, Rockcastle, Rowan, Scott, Whitley, Wolfe, Woodford						

LOUISIANA						
Fleet Logistics Center, Jacksonville, FL (CNNQ)	22.86	26.65	0.94	6.61	0.15	D
Acadia, Allen, Arcadia, Ascension, Assumption, Avoyelles, Beauregard, Calcasieu, Cameron, Catahoula, Concordia, East Baton Rouge, East Feliciana, Evangeline, Grant, Iberia, Iberville, Jefferson, Jefferson Davis, Lafayette, Lafourche, La Salle, Livingston, Natchitoches, Orleans, Plaquemines, Point Coupee, Rapides, Sabine, St. Bernard, St. Charles, St. Helena, St. James, St. John the Baptist, St. Landry, St. Martin, St. Mary, St. Tammany, Tangipahoa, Terrebonne, Vermilion, Vernon, Washington, West Baton Rouge, West Feliciana, Winn						
JPPSO-SC, San Antonio, TX (HAFC)	18.40	24.00	0.79	5.30	0.15	B
Bienville, Bossier, Caddo, Caldwell, Claiborne, De Soto, East Carroll, Franklin, Jackson, Lincoln, Madison, Morehouse, Ouachita, Red River, Richland, Tensas, Union, Webster, West Carroll						

MAINE						
JPPSO-NE, Chelmsford, MA (AGFM)	25.80	32.89	1.33	7.47	0.17	I
Androscoggin, Aroostook, Cumberland, Franklin, Hancock, Kennebec, Knox, Lincoln, Oxford, Penobscot, Piscataquis, Sagadahoc, Somerset, Waldo, Washington, York						

Item 502 Labor Reg	Item 502 Labor O/T	Item 532 Long Carry	Item 518 SIT 1st Day & W/H	Item 518 SIT Ea. Add'l Day	Item 520 SIT P/D Schedules
502A	502B	532A	518B	518A	520A

MARYLAND						
JPPSO-NE, Chelmsford, MA (AGFM)	18.41	24.00	0.79	5.19	0.14	A
Caroline, Dorchester, Kent, Queen Annes, Somerset, Talbot, Wicomico, Worcester						
JPPSO-Mid Atlantic, Fort Belvoir, VA (BGAC)	36.67	45.14	0.79	7.92	0.17	J
Allegany, Anne Arundel (Army/Air Force/Coast Guard and those Navy/Marine Corps stationed at Ft. Meade), Baltimore, Baltimore City, Carroll, Cecil, Charles, Frederick, Garrett, Harford, Howard, Montgomery, Prince Georges, Washington						
Fleet Logistics Center, Norfolk, VA (BGNC)	31.01	40.61	0.79	7.92	0.17	J
Anne Arundel (Navy/Marine Corps EXCEPT those personnel assigned to Ft. Meade, MD), Calvert, Saint Marys						

MASSACHUSETTS						
JPPSO-NE, Chelmsford, MA (AGFM)	37.43	49.49	1.65	9.87	0.18	N
Barnstable, Berkshire, Bristol, Dukes, Essex, Franklin, Hampden, Hampshire, Middlesex, Nantucket, Norfolk, Plymouth, Suffolk, Worcester						

MICHIGAN						
JPPSO-Mid Atlantic, Fort Belvoir, VA (BGAC)	51.30	63.91	1.65	11.85	0.18	P
Alcona, Allegan, Alpena, Antrim, Arenac, Barry, Bay, Benzie, Berrien, Branch, Calhoun, Cass, Charlevoix, Cheboygan, Clare, Clinton, Crawford, Eaton, Emmet, Genesee, Gladwin, Grand Traverse, Gratiot, Hillsdale, Huron, Ingham, Ionia, Iosco, Isabella, Jackson, Kalamazoo, Kalkaska, Kent, Lake, Lapeer, Leelanau, Lenawee, Livingston, Macomb, Manistee, Mason, Mecosta, Midland, Missaukee, Monroe, Montcalm, Montmorency, Muskegon, Newaygo, Oakland, Oceana, Ogemaw, Osceola, Oscoda, Otsego, Ottawa, Presque Isle, Roscommon, Saginaw, Saint Clair, Saint Joseph, Sanilac, Shiawassee, Tuscola, Van Buren, Washtenaw, Wayne, Wexford						
JPPSO-NC, Colorado Springs, CO (KKFA)	32.82	46.99	1.33	8.11	0.17	G
Alger, Baraga, Chippewa, Delta, Dickinson, Gogebic, Houghton, Iron, Keweenaw, Luce, Mackinac, Marquette, Menominee, Ontonagon, Schoolcraft						

MINNESOTA						
JPPSO-NC, Colorado Springs, CO (KKFA)	51.30	63.57	1.65	10.66	0.18	O
Aitkin, Anoka, Becker, Beltrami, Benton, Big Stone, Blue Earth, Brown, Carlton, Carver, Cass, Chippewa, Chisago, Clay, Clearwater, Cook, Cottonwood, Crow Wing, Dakota, Dodge, Douglas, Faribault, Fillmore, Freeborn, Goodhue, Grant, Hennepin, Houston, Hubbard, Isanti, Itasca, Jackson, Kanabec, Kandiyohi, Kittson, Koochiching, Lac qui Parle, Lake, Lake of the Woods, Le Sueur, Lincoln, Lyon, Mahnomon, Marshall, Martin, McLeod, Meeker, Mille Lacs, Morrison, Mower, Murray, Nicollet, Nobles, Norman, Olmsted, Otter Tail, Pennington, Pine, Pipestone, Polk, Pope, Ramsey, Red Lake, Redwood, Renville, Rice, Rock, Roseau, Scott, Sherburne, Sibley, St. Louis, Stearns, Steele, Stevens, Swift, Todd, Traverse, Wabasha, Wadena, Waseca, Washington, Watonwan, Wilkin Winona, Wright, Yellow Medicine						

MISSISSIPPI						
Fleet Logistics Center, Jacksonville, FL (CNNQ)	20.15	26.73	0.79	6.25	0.15	E
Adams, Alcorn, Benton, Claiborne, Clarke, Coahoma, Copiah, De Soto, Hinds, Issaquena, Jasper, Jefferson, Kemper, Lafayette, Lauderdale, Leake, Madison, Marshall, Neshoba, Newton, Panola, Prentiss, Quitman, Rankin, Scott, Sharkey, Simpson, Smith, Tate, Tippah, Tishomingo, Tunica, Union, Warren, Yazoo						
JPPSO-SC, San Antonio, TX (HAFB)	18.41	24.00	0.79	4.88	0.15	F
Amite, Attala, Bolivar, Calhoun, Carroll, Chickasaw, Choctaw, Clay, Covington, Forrest, Franklin, George Greene, Grenada, Hancock, Harrison, Holmes, Humphreys, Itawamba, Jackson, Jefferson Davis, Jones, Lamar, Lawrence, Lee, Leflore, Lincoln, Lowndes, Marrion, Monroe, Montgomery, Noxubee, Oktibbeha, Pearl River, Perry, Pike, Pontotoc, Stone, Sunflower, Tallahatchie, Walthall, Washington, Wayne, Webster, Wilkinson, Winston, Yalobusha						

Item 502 Labor Reg	Item 502 Labor O/T	Item 532 Long Carry	Item 518 SIT 1st Day & W/H	Item 518 SIT Ea. Addt'l Day	Item 520 SIT P/D Schedules
502A	502B	532A	518B	518A	520A

MISSOURI						
JPPSO-NE, Chelmsford, MA (AGFM)	36.18	47.95	0.94	7.87	0.15	M
Adair, Bollinger, Cape, Clark, Girardeau, Iron, Jefferson, Knox, Lewis, Lincoln, Madison, Marion, Perry, Pike, Putnam, Ralls, Reynolds, Scott, Schuyler, Scotland, St. Charles, St. Francois, St. Genevieve, St. Louis, St. Louis City, Stoddard, Sullivan, Wayne						
JPPSO-SC, San Antonio, TX (HAFC)	18.41	24.00	0.79	4.88	0.14	M
Butler, Carter, Dunklin, Mississippi, New Madrid, Pemiscot, Ripley						
JPPSO-NW, JB Lewis-McChord, WA (JEAT)	45.14	59.21	1.65	9.14	0.17	M
Andrew, Atchison, Bardar, Barry, Bates, Buchanan, Caldwell, Camden, Carroll, Cass, Cedar, Chariton, Christian, Clay, Clinton, Crawford, Dade, Dallas, Daviess, De Kalb, Dent, Douglas, Franklin, Gasconade, Gentry, Greene, Grundy, Harrison, Holt, Howell, Jackson, Jasper, Laclede, Lawrence, Linn, Livingston, Macon, Maries, McDonald, Mercer, Miller, Monroe, Montgomery, Newton, Nodaway, Oregon, Ozark, Phelps, Platte, Polk, Pulaski, Randolph, Ray, Shannon, Shelby, Stone, Taney, Texas, Vernon, Warren, Washington, Webster, Worth, Wright						
JPPSO-NC, Colorado Springs, CO (KKFA)	45.03	59.04	1.65	8.96	0.15	M
Audrain, Benton, Boone, Callaway, Cole, Cooper, Henry, Hickory, Howard, Johnson, Lafayette, Moniteau, Morgan, Osage, Pettis, Saint Clair, Saline						

MONTANA						
JPPSO-NC, Colorado Springs, CO (KKFA)	39.72	50.82	1.65	11.28	0.17	K
All counties						

NEBRASKA						
JPPSO-NW, JB Lewis-McChord, WA (JEAT)	18.41	24.00	0.94	4.88	0.14	B
Johnson, Nemaha, Pawnee, Richardson						
JPPSO-NC, Colorado Springs, CO (KKFA)	36.35	44.50	1.65	7.95	0.15	J
Adams, Antelope, Arthur, Banner, Blaine, Boone, Box Butt, Boyd, Brown, Buffalo, Burt, Butler, Cass, Cedar, Chase, Cherry, Cheyenne, Clay, Colfax, Cuming, Custer, Dakota, Dawes, Dawson, Deuel, Dixon, Dodge, Douglas, Dundy, Fillmore, Franklin, Frontier, Furnas, Gage, Garfield, Garden, Gosper, Grant, Greeley, Hall, Hamilton, Harlan, Hayes, Hitchcock, Holt, Hooker, Howard, Jefferson, Kearney, Keith, Keya Paha, Kimball, Knox, Lancaster, Lincoln, Logan, Loup, McPherson, Madison, Merrick, Morrill, Nance, Nuckolls, Otoe, Perkins, Phelps, Pierce, Platte, Polk, Red Willow, Rock, Saline, Sarpy, Saunders, Scotts Bluff, Seward, Sheridan, Sherman, Sloux, Stanton, Thayer, Thomas, Thurston, Valley, Washington, Wayne, Webster, Wheeler, York						

NEVADA						
JPPSO-NC, Colorado Springs, CO (KKFA)	46.14	59.38	0.94	9.45	0.17	K
Clark, Lincoln, Nye (South of US Rt. 6)						
Fleet Logistics Center, San Diego, CA (LKNQ)	32.40	43.84	1.65	9.26	0.17	H
Carson City, Churchill, Douglas, Elko, Esmeralda, Eureka, Humboldt, Lander, Lyon, Mineral, Nye (North of US Rt. 6), Pershing, Storey, Washoe, White Pine						

NEW HAMPSHIRE						
JPPSO-NE, Chelmsford, MA (AGFM)	22.62	30.03	1.65	9.69	0.18	L
Belknap, Carroll, Cheshire, Grafton, Hillsborough, Merrimack, Rockingham, Strafford, Sullivan						

NEW JERSEY						
JPPSO-NE, Chelmsford, MA (AGFM)	36.67	45.14	1.65	10.45	0.21	K
Atlantic, Burlington, Camden (East of Turnpike), Cape May, Cumberland, Gloucester, Hunterdon, Mercer, Middlesex, Monmouth, Ocean, Salem, Somerset, Warren						
JPPSO-Mid Atlantic, Fort Belvoir, VA (BGAC)	33.97	50.00	1.65	10.78	0.21	N
Bergen, Essex, Hudson, Morris, Passaic, Sussex, Union						
Fleet Logistics Center, Norfolk, VA (BGNC)	27.39	39.14	1.33	8.11	0.18	K
Camden (West of Turnpike)						

Item 502 Labor Reg	Item 502 Labor O/T	Item 532 Long Carry	Item 518 SIT 1st Day & W/H	Item 518 SIT Ea. Addt'l Day	Item 520 SIT P/D Schedules
502A	502B	532A	518B	518A	520A

NEW MEXICO						
JPPSO-NC, Colorado Springs, CO (KKFA)	26.80	40.38	0.79	7.97	0.17	G
Bernalillo, Catron, Chaves, Cibola, Colfax, Curry, De Baca, Eddy, Dona Ana, Grant, Guadalupe, Harding, Hidalgo, Lea, Lincoln, Los Alamos, Luna, McKinley, Mora, Otero, Quay, Rio Arriba, Roosevelt, Sandoval, San Juan, San Miguel, Santa Fe, Taos, Sierra, Socorro, Torrance, Union, Valencia						

NEW YORK						
JPPSO-NE, Chelmsford, MA (AGFM)	45.14	59.95	1.65	12.09	0.21	N
Albany, Allegany, Broome, Cattaraugus, Cayuga, Chautauqua, Chemung, Chenango, Clinton, Columbia, Cortland, Delaware, Erie, Essex, Franklin, Fulton, Genesee, Greene, Hamilton, Herkimer, Livingston, Madison, Monroe, Montgomery, Niagara, Oneida, Onondaga, Ontario, Orleans, Otsego, Rensselaer, Saratoga, Schenectady, Schoharie, Schuyler, Seneca, Steuben, Suffolk (Fisher Island, NY), Tioga, Tompkins, Warren, Washington, Wayne, Wyoming, Yates						
JPPSO-Mid Atlantic, Fort Belvoir, VA (BGAC)	42.42	59.95	1.65	12.09	0.22	O
Bronx, Dutchess, Jefferson, Kings (including Brooklyn), Lewis, Nassau, New York (including Borough of Manhattan), Orange, Oswego, Putnam, Queens, Richmond, Rockland, St. Lawrence, Suffolk (excluding Fishers Island), Sullivan, Ulster, Westchester						

NORTH CAROLINA						
JPPSO-NE, Chelmsford, MA (AGFM)	21.22	28.86	1.33	5.39	0.14	C
Durham, Edgecombe, Franklin, Granville, Greene, Halifax, Johnston, Lenoir, Martin, Nash, Orange, Person, Pitt, Vance, Wake, Warren, Wayne, Wilson						
Fleet Logistics Center, Norfolk, VA (BGNC)	18.41	24.00	0.79	4.88	0.14	A
Bertie, Camden, Chowan, Currituck, Dare, Gates, Hertford, Northampton, Pasquotank, Perquimans, Tyrrell, Washington						
Fort Bragg, NC (BKAS)	22.03	28.86	1.33	6.00	0.15	D
Alamance, Alexander, Alleghany, Anson, Ashe, Avery, Bladen, Buncombe, Burke, Cabarrus, Caldwell, Caswell, Catawba, Chatham, Cherokee, Clay, Cleveland, Cumberland, Davidson, Davie, Forsyth, Gaston, Graham, Guilford, Harnett, Haywood, Henderson, Hoke, Iredell, Jackson, Lee, Lincoln, McDowell, Macon, Madison, Mecklenburg, Mitchell, Montgomery, Moore, Polk, Randolph, Richmond, Robeson, Rockingham, Rowan, Rutherford, Sampson, Scotland, Stanly, Stokes, Surry, Swain, Transylvania, Union, Watauga, Wilkes, Yadkin, Yancey						
JPPSO-SE, Jacksonville, FL (CNNQ)	18.41	24.00	0.79	5.39	0.14	B
Beaufort, Brunswick, Carteret, Columbus, Craven, Duplin, Hyde, Jones, New Hanover, Onslow, Pamlico, Pender						

NORTH DAKOTA						
JPPSO-NC, Colorado Springs, CO (KKFA)	31.57	41.12	1.33	8.64	0.17	H
Adams, Barnes, Benson, Billings, Bottineau, Bowman, Burke, Burleigh, Cass, Cavalier, Dickey, Divide, Dunn, Eddy, Emmons, Foster, Golden Valley, Grand Forks, Grant, Griggs, Hettinger, Kidder, Logan, McHenry, McIntosh, McKenzie, McLean, Mercer, Morton, Mountrail, La Moure, Nelson, Oliver, Pembina, Pierce, Ramsey, Ransom, Renville, Williams Richland, Rolette, , Sargent , Sheridan, Sioux, Slope, Steele, Stutsman, Stark, Towner, Traill, Walsh, Ward, Wells						

OHIO						
JPPSO-NE, Chelmsford, MA (AGFM)	47.02	65.79	1.65	10.32	0.21	M
Allen, Ashland, Ashtabula, Athens, Auglaize, Belmont, Butler, Carroll, Champaign, Clark, Clinton, Columbiana, Coshocton, Crawford, Cuyahoga, Darke, Defiance, Delaware, Erie, Fairfield, Fayette, Franklin, Fulton, Gallia, Geauga, Greene, Guernsey, Hancock, Hardin, Harrison, Henry, Highland, Hocking, Holmes, Huron, Jackson, Jefferson, Knox, Lake, Lawrence, Licking, Logan, Lorain, Lucas, Madison, Mahoning, Marion, Medina, Meigs, Mercer, Miami, Monroe, Montgomery, Morgan, Morrow, Muskingum, Noble, Ottawa, Paulding, Perry, Pickaway, Pike, Portage, Preble, Putnam, Richland, Ross, Sandusky, Scioto, Seneca, Shelby, Stark, Summit, Trumbull, Tuscarawas, Union, Van Wert, Vinton, Warren, Washington, Wayne, Williams, Wood, Wyandot						
JPPSO-NC, Colorado Springs, CO (KKFA)	35.45	53.04	0.94	10.01	0.18	J
Adams, Brown, Clermont, Hamilton						

Item 502 Labor Reg	Item 502 Labor O/T	Item 532 Long Carry	Item 518 SIT 1st Day & W/H	Item 518 SIT Ea. Addt'l Day	Item 520 SIT P/D Schedules
502A	502B	532A	518B	518A	520A

OKLAHOMA						
JPPSO-SC, San Antonio, TX (HAFB)	40.38	56.50	1.33	7.29	0.15	H
Alfalfa, Atoka, Beaver, Blaine, Beckham, Bryan, Canadian, Choctaw, Cleveland, Coal, Cotton, Creek, Custer, Dewey, Ellis, Garfield, Grant, Greer, Harmon, Harper, Haskell, Hughes, Jackson, Jefferson, Johnston, Kay, Kingfisher, Latimer, Lincoln, Logan, Love, Major, Marshall, McCurtain, McIntosh, Muskogee, Noble, Okfuskee, Oklahoma, Okmulgee, Osage, Pawnee, Payne, Pittsburg, Pontotoc, Pottawatomie, Pushmataha, Roger Mills, Seminole, Tillman, Tulsa, Wagoner, Washington, Washita, Woods, Woodward						
JPPSO-NW, JB Lewis-McChord, WA (JEAT)	40.38	56.50	1.33	5.90	0.15	H
Adair, Caddo, Carter, Cherokee, Comanche, Craig, Delaware, Garvin, Grady, Kiowa, Le Flore, McClain, Mayes, Murray, Nowata, Ottawa, Rogers, Sequoyah, Stephens						
JPPSO-NC, Colorado Springs, CO (KKFA)	18.41	24.00	0.79	4.88	0.14	A
Cimarron, Texas						

OREGON						
JPPSO-NW, JB Lewis-McChord, WA (JEAT)	52.88	70.56	1.65	11.77	0.21	P
Benton, Clackamas, Clatsop, Columbia, Coos, Curry, Douglas, Gilliam, Hood River, Jackson, Josephine, Klamath, Lane, Lincoln, Linn, Marion, Morrow, Multnomah, Polk, Sherman, Tillamook, Wasco, Washington, Yamhill						
JPPSO-NC, Colorado Springs, CO (KKFA)	47.95	64.62	0.94	10.59	0.17	I
Baker, Crook, Deschutes, Grant, Harney, Jefferson, Lake, Malheur, Umatilla, Union, Wallowa, Wheeler						

PENNSYLVANIA						
JPPSO-NE, Chelmsford, MA (AGFM)	51.40	63.91	1.65	11.16	0.21	N
Allegheny, Armstrong, Beaver, Butler, Cambria, Cameron, Carbon, Clarion, Clearfield, Crawford, Elk, Erie, Fayette, Forest, Greene, Indiana, Jefferson, Lackawanna, Lawrence, Luzerne, McKean, Mercer, Monroe, Pike, Somerset, Susquehanna, Venango, Warren, Washington, Wayne, Westmoreland, Wyoming						
JPPSO-Mid Atlantic, Fort Belvoir, VA (BGAC)	45.14	55.02	1.65	11.85	0.18	N
Adams, Bedford, Berks, Blair, Bradford, Centre, Clinton, Columbia, Cumberland, Dauphin, Franklin, Fulton, Huntingdon, Juniata, Lancaster, Lebanon, Lycoming, Mifflin, Montour, Northumberland, Perry, Potter, Schuylkill, Snyder, Sullivan, Tioga, Union, York						
Fleet Logistics Center, Norfolk, VA (BGNC)	39.88	53.33	1.65	10.01	0.18	N
Bucks, Chester, Delaware, Lehigh, Montgomery, Northampton, Philadelphia						

RHODE ISLAND						
JPPSO-NE, Chelmsford, MA (AGFM)	29.76	40.29	0.94	7.38	0.15	G
Bristol, Kent, Newport, Providence, Washington						

SOUTH CAROLINA						
JPPSO-NE, Chelmsford, MA (AGFM)	18.75	24.58	0.79	5.71	0.15	D
Bamberg, Berkeley, Charleston, Chesterfield, Clarendon, Colleton, Darlington, Dillon, Dorchester, Florence, Georgetown, Horry, Kershaw, Lancaster, Lee, Marion, Marlboro, Orangeburg Sumter, Williamsburg						
JPPSO-SE, Jacksonville, FL (CNNQ)	23.03	30.19	1.33	5.90	0.15	D
Abbeville, Aiken, Allendale, Anderson, Barnwell, Beaufort, Calhoun, Cherokee, Chester, Edgefield, Fairfield, Greenville, Greenwood, Hampton, Jasper, Laurens, Lexington, McCormick, Newberry, Oconee, Pickens, Richland, Saluda, Spartanburg, Union, York						

SOUTH DAKOTA						
JPPSO-NC, Colorado Springs, CO (KKFA)	36.35	44.50	1.65	7.90	0.15	J
All Counties						

Item 502 Labor Reg	Item 502 Labor O/T	Item 532 Long Carry	Item 518 SIT 1st Day & W/H	Item 518 SIT Ea. Addt'l Day	Item 520 SIT P/D Schedules
502A	502B	532A	518B	518A	520A

TENNESSEE						
JPPSO Mid-Atlantic, VA (BGAC)	20.97	27.73	0.79	6.03	0.15	D
Bedford, Benton, Cannon, Carroll, Cheatham, Coffee, Davidson, Decatur, De Kalb, Dickson, Franklin, Henry, Hickman, Houston, Humphreys, Lake, Macon, Montgomery, Moore, Obion, Perry, Robertson, Rutherford, Smith, Stewart, Sumner, Trousdale, Weakley, Williamson, Wilson						
JPPSO-SE, Jacksonville, FL (CNNQ)	25.73	33.46	1.33	6.25	0.15	E
Anderson, Bledsoe, Blount, Bradley, Campbell, Carter, Chester, Claiborne, Clay, Cocke, Crockett, Cumberland, Dyer, Fayette, Fentress, Gibson, Giles, Grainger, Greene, Grundy, Hamblen, Hamilton, Hancock, Hardeman, Hardin, Hawkins, Haywood, Henderson, Jackson, Jefferson, Johnson, Knox, Lauderdale, Lawrence, Lewis, Lincoln, Loudon, Madison, Marion, Marshall, Maury, McMinn, McNairy, Meigs, Monroe, Morgan, Overton, Pickett, Polk, Putnam, Rhea, Roane, Scott, Sequatchie, Sevier, Shelby, Sullivan, Unicoi, Union, Tipton, Van Buren, Warren, Washington, Wayne, White						

TEXAS						
JPPSO-SE, Jacksonville, FL (CNNQ)	23.03	30.19	1.33	6.47	0.15	E
Angelina, Jasper, Nacogdoches, Newton, Orange, Sabine, San Augustine, Shelby						
JPPSO-SC, San Antonio, TX (HAFC)	25.73	37.91	1.33	8.91	0.17	G
Anderson, Andrews, Aransas, Atascosa, Archer, Austin, Bandera, Bastrop, Baylor, Bee, Bexar, Blanco, Borden, Bowie, Brazoria, Brazos, Brooks, Burleson, Caldwell, Calhoun, Callahan, Cameron, Camp, Cass, Chambers, Cherokee, Childress, Clay, Coke, Coleman, Collin, Collingsworth, Colorado, Comal, Concho, Cooke, Crane, Crockett, Dallas, Dawson, Delta, Denton, De Witt, Dimmit, Donley, Duval, Eastland, Ector, Edwards, Ellis, Erath, Fannin, Fayette, Fisher, Foard, Fort Bend, Franklin, Freestone, Frio, Gaines, Galveston, Garza, Gillespie, Glasscock, Goliad, Gonzales, Gray, Grayson, Gregg, Grimes, Guadalupe, Hall, Hardeman, Hardin, Harris, Harrison, Haskell, Hays, Henderson, Hemphill, Hidalgo, Hood, Hopkins, Houston, Howard, Hunt, Irion, Jack, Jackson, Jefferson, Jim Hogg, Jim Wells, Johnson, Jones, Karnes, Kaufman, Kendall, Kenedy, Kent, Kerr, Kimble, Kinney, Kleberg, Knox, La Salle, Lamar, Lavaca, Lee, Leon, Liberty, Lipscomb, Live Oak, Lynn, Madison, Marion, Martin, Matagorda, Maverick, McMullen, Medina, Mernard, Midland, Milam, Mitchell, Montague, Montgomery, Morris, Navarro, Nolan, Nueces, Ochiltree, Palo Pinto, Panola, Parker, Polk, Rains, Reagan, Real, Red River, Refugio, Roberts, Robertson, Rockwall, Runnels, Rusk, San Jacinto, San Patricio, Schleicher, Scurry, Shackelford, Smith, Somervell, Star, Stephens, Sterling, Stonewall, Sutton, Tarrant, Taylor, Terry, Throckmorton, Titus, Tom Green, Travis, Trinity, Tyler, Upshur, Upton, Uvalde, Val Verde, Van Zandt, Victoria, Walker, Waller, Washington, Webb, Wharton, Wheeler, Wichita, Wilbarger, Willacy, Williamson, Wilson, Wise, Wood, Yoakum, Young, Zapata, Zavala						
Fort Hood, TX (HBAT)	18.41	24.00	0.79	5.71	0.14	C
Bell, Bosque, Brewster, Brown, Burnet, Comanche, Coryell, Culberson, El Paso, Falls, Hamilton, Hill, Hudspeth, Jeff Davis, Lampasas, Limestone, Llano, Loving, McCulloch, McLennan, Mason, Mills, Pecos, Presidio, Reeves, San Saba, Terrell, Ward, Winkler						
JPPSO-NC, Colorado Springs, CO (KKFA)	25.73	33.46	1.33	6.38	0.15	E
Armstrong, Bailey, Briscoe, Carson, Castro, Cochran, Cottle, Crosby, Dallam, Deaf Smith, Dickens, Floyd, Hale, Hansford, Hartley, Hockley, Hutchinson, King, Lamb, Lubbock, Moore, Motley, Oldham, Parmer, Potter, Randall, Sherman, Swisher						

UTAH						
JPPSO-COS, Colorado Springs, CO (KKFA)	31.83	42.35	0.94	8.53	0.17	H
Beaver, Box Elder, Cache, Carbon, Daggett, Davis, Duchesne, Emery, Garfield, Grand, Iron, Juab, Kane, Millard, Morgan, Piute, Rich, Salt Lake, San Juan, Sanpete, Sevier, Summit, Tooele, Uintah, Utah, Wasatch, Washington, Wayne, Weber						

VERMONT						
JPPSO-NE, Chelmsford, MA (AGFM)	19.73	25.58	0.79	7.76	0.15	E
Addison, Bennington, Caledonia, Chittenden, Essex, Franklin, Grand Isle, Lamoille, Orange, Orleans, Rutland, Washington, Windham, Windsor						

Item 502 Labor Reg	Item 502 Labor O/T	Item 532 Long Carry	Item 518 SIT 1st Day & W/H	Item 518 SIT Ea. Addt'l Day	Item 520 SIT P/D Schedules
502A	502B	532A	518B	518A	520A

VIRGINIA						
JPPSO-NE, Chelmsford, MA (AGFM)	26.65	34.70	0.79	5.71	0.15	C
Charles City, Gloucester, James City, King and Queen, King William, Lancaster, Mathews, Middlesex, New Kent, York; Independent cities of: Hampton, Newport News, Poquoson, Williamsburg						
JPPSO-Mid Atlantic, Fort Belvoir, VA (BGAC)	31.01	40.61	1.33	7.92	0.17	J
Albemarle, Alleghany, Amelia, Amherst, Appomattox, Arlington, Augusta, Bath, Bedford, Bland, Botetourt, Brunswick, Buchanan, Buckingham, Campbell, Caroline, Carroll, Charlotte, Chesterfield, Clarke, Craig, Culpeper, Cumberland, Dickenson, Dinwiddie, Essex, Fairfax, Fauquier, Floyd, Fluvanna, Franklin, Frederick, Giles, Goochland, Grayson, Greene, Greensville, Halifax, Hanover, Henrico, Henry, Highland, King George, Lee, Loudoun, Louisa, Lunenburg, Madison, Mecklenburg, Montgomery, Nelson, Northumberland, Nottoway, Orange, Page, Patrick, Pittsylvania, Powhatan, Prince Edward, Prince George, Prince William, Pulaski, Rappahannock, Richmond, Roanoke, Rockbridge, Rockingham, Russell, Scott, Shenandoah, Smyth, Spotsylvania, Stafford, Sussex, Tazewell, Warren, Washington, Westmoreland, Wise, Wythe; Independent cities of: Alexandria, Bedford, Bristol, Buena Vista, Charlottesville, Clifton Forge, Colonial Heights, Covington, Danville, Emporia, Fairfax, Falls Church, Fredericksburg, Galax, Harrisonburg, Hopewell, Lexington, Lynchburg, Manassas, Manassas Park, Martinsville, Norton, Petersburg, Radford, Richmond, Roanoke, Salem, South Boston, Staunton, Waynesboro, Winchester						
Fleet Logistics Center, Norfolk, VA (BGNC)	26.65	34.70	0.79	5.71	0.15	C
Accomack, Isle of Wight, Northampton, Southampton, Surry; Independent cities of: Chesapeake, Franklin, Norfolk, Portsmouth, Suffolk, Virginia Beach						

WASHINGTON						
JPPSO-NW, JB Lewis-McChord, WA (JEAT)	52.96	70.56	1.65	12.29	0.21	P
Benton, Chelan (Navy/Marine Corps/Coast Guard), Clallam, Clark, Cowlitz, Grays Harbor, Island, Jefferson, King (Army/Air Force/Navy/Marine Corps/Coast Guard), Kittitas (Army/Air Force/Navy/Marine Corps/Coast Guard), Kitsap, Klickitat, Lewis, Mason, Pacific, Pierce, San Juan, Skagit, Skamania, Snohomish, Thurston, Wahkiakum, Whatcom, Yakima						
JPPSO-NC, Colorado Springs, CO (KKFA)	36.18	47.95	0.79	8.37	0.15	I
Adams, Asotin, Chelan (Army/Air Force), Columbia, Douglas, Ferry, Franklin, Garfield, Grant, Lincoln, Okanogan, Pend Oreille, Spokane, Stevens, Walla Walla, Whitman						

WEST VIRGINIA						
JPPSO-NE, Chelmsford, MA (AGFM)	41.53	54.85	1.33	9.69	0.17	K
Barbour, Boone, Braxton, Brooke, Cabell, Calhoun, Clay, Doddridge, Fayette, Gilmer, Greenbrier, Hancock, Harrison, Jackson, Kanawha, Lewis, Lincoln, Logan, Marion, Marshall, Mason, Mingo, Monongalia, Nicholas, Ohio, Pleasants, Preston, Putnam, Raleigh, Ritchie, Roane, Taylor, Tyler, Upshur, Wayne, Wetzel, Wirt, Wood, Wyoming						
JPPSO-Mid Atlantic, Fort Belvoir, VA (BGAC)	36.43	54.61	1.33	6.19	0.15	C
Berkeley, Grant, Hampshire, Hardy, Jefferson, McDowell, Mercer, Mineral, Monroe, Morgan, Pendleton, Pocahontas, Randolph, Summers, Tucker, Webster						

WISCONSIN						
Fleet Logistics Center, Norfolk, VA (BGNC)	37.58	56.50	1.65	11.61	0.18	I
Adams, Brown, Calumet, Columbia, Crawford, Dane, Dodge, Door, Fond du Lac, Grant, Green, Green Lake, Iowa, Jefferson, Juneau, Kenosha, Kewaunee, Lafayette, Langlade, Lincoln, Manitowoc, Marathon, Marquette, Menominee, Milwaukee, Oconto, Outagamie, Ozaukee, Portage, Racine, Richland, Rock, Sauk, Shawano, Sheboygan, Vernon, Walworth, Washington, Waukesha, Waupaca, Waushara, Winnebago, Wood						
JPPSO-NC, Colorado Springs, CO (KKFA)	45.14	58.55	1.65	11.85	0.18	J
Ashland, Barron, Bayfield, Buffalo, Burnett, Chippewa, Clark, Douglas, Dunn, Eau Claire, Florence, Forest, Iron, Jackson, LaCrosse, Marinette, Monroe, Oneida, Pepin, Pierce, Polk, Price, Rusk, St. Croix, Sawyer, Taylor, Trempealeau, Vilas, Washburn						

WYOMING						
JPPSO-NC, Colorado Springs, CO (KKFA)	31.83	42.35	1.33	8.53	0.17	H
All Counties						

Item 501 - Shuttle Services (Auxiliary Service)

(501A) - Auxiliary Vehicle

(501B) - Auxiliary Service: Labor (Regular)

(501C) - Auxiliary Service: Labor (Overtime)

(501D) - Auxiliary Service: Labor (Alaska)

1. All Shuttle Services require pre-approval from the Government. The request must include comprehensive notes explaining the limitations preventing the linehaul equipment from accessing the origin/destination. Valid limitations include but are not limited to the following:
 - a. Structure of the building.
 - b. Inaccessibility by highway.
 - c. Inadequate or unsafe public or private road.
 - d. Overhead obstructions.
 - e. Narrow gates.
 - f. Sharp turns.
 - g. Trees, shrubbery.
 - h. Deterioration of roadway due to rain, flood, snow.
 - i. Nature of an article or articles included in the shipment.
2. This item applies when
 - a. TSP requests shuttle service for pickup or delivery occurring at a location preventing the linehaul equipment from accessing the origin or destination.
 - b. TSP performs a truck-to-truck transfer only.
 - c. PPSO approves the TSP request, and the customer signs the pickup/delivery documentation, or inspection by PPSO personnel will validate the performance of the service.
3. Shuttle Service does not apply when:
 - a. The shipment is taken from the residence to await linehaul transportation. Only in unusual circumstances, the Government may approve a shuttle service request.
 - b. Delivered from SIT, shuttle service will not normally be approved.
 - c. When the shipment is picked up by the TSP/agent or delivered from SIT, shuttle service will not normally be approved, unless there are unusual circumstances, and the Government has reviewed and approved the request.
4. Shuttle charges include the cost of the shuttle vehicle and labor required to perform the shuttle service and shall apply:
 - a. At the point where service is performed.
 - b. Shuttle service charges and/or extra labor charges, shall be in addition to all other transportation or accessorial charges.

-
- c. When Shuttle Service OT is requested by the Government,
 - (1) OT charges apply when service is performed between 5:00 p.m. and 8:00 a.m., Monday through Friday, or at any time on Saturdays, Sundays, and U.S. National Holidays.
 - (2) OT charges will not apply when service performed for TSPs convenience.
 5. Nearest point of safe approach:
 - a. The customer is responsible to make the shipment accessible to the TSP or accept delivery from TSP at a point at which the normally assigned linehaul vehicle/equipment may be safely operated.
 - b. TSP shall hold itself available at point of pickup or tender delivery at destination at the nearest point of approach to the desired location where the linehaul vehicle/equipment can be made safely accessible.
 - c. If the customer does not accept the shipment at the nearest point of safe approach, the TSP, upon Government approval, may place the shipment or any part thereof not reasonably possible for delivery, in storage at the nearest available Government approved warehouse of the TSP. The responsible PPSO must be informed of such action prior to placement in warehouse.
 6. The transportation charges to cover the movement of shipment shall be
 - a. Per additional vehicle: **\$30.61** (501A) per hour
 - b. Labor: See Item 502
 7. Use applicable labor rates contained in Item 502 when billing services under Item 501B, 501C, or 501D.
 8. To support payment TSP must submit a DD Form 619 signed by the customer to validate that requested services were performed.
 9. The following additional documentation may be requested by GSA and/or PPSO to support payment:
 - a. Signed dispatch logs indicating the driver and equipment specifics used to perform the truck-to-truck transfer, with dates.
 - b. Paid equipment rental receipts (if utilized, receipts must be in English) and/or Driver Cab Logs (whichever is applicable) indicating
 - (1) equipment type,
 - (2) duration of use,
 - (3) date used, and
 - (4) location of use
 - c. Copy of the vehicle registration if a vehicle from an agent was used.
 10. Rental equipment used for a shuttle is not reimbursable.

Item 502 - Labor Charges

(502A) - Labor (Regular)

(502B) - Labor (Overtime)

(502C) - Labor (Alaska)

1. Use applicable rate based upon the location of the service, time of the service, and whether the shipment is considered HHG or UB when billing labor services under Items 502A, 502B, or 502C.
2. Covers all services for which no charges are otherwise provided when such services are authorized and confirmed in writing on a DD Form 619 by the responsible PPSO. PPSO may authorize additional labor in the handling of gun safes over 300 pounds. If approved, labor will be billed utilizing Item 502 Labor Charges (with an EDI billing note explaining use).
3. Charges based on time shall be computed by multiplying the hourly rate by the time involved. Unless otherwise provided, fractions of an hour will be disposed of as follows:
 - a. Where the time involved is 15 minutes or less, the charge shall be for 1/4 hour.
 - b. When more than 15 minutes but not more than 30 minutes, the charge shall be for 1/2 hour.
 - c. When more than 30 minutes but not more than 45 minutes, the charge shall be for 3/4 hour.
 - d. When more than 45 minutes, but no more than 60 minutes, the charge shall be for 1 hour.
4. See State GBLOC Item 500 Table, Geographical Application of Rates and Schedules, for labor rates to apply to HHG shipments when service is performed at points within CONUS.
5. The following labor rates will apply to **UB** shipments performed at points within CONUS:

	RATES \$	
	Per Man Hour	
	Regular (502A)	Overtime (502B)
SERVICE AREA		
CALIFORNIA: When service is performed in the state of CA, PPSO area of responsibility with KKFA and LHNQ, these rates apply:	\$46.20	\$64.13
NEW YORK: When service is performed in the state of NY, area of responsibility of BGAC and AGFM, these rates apply:	\$38.50	\$51.72
ALL OTHER POINTS WITHIN CONUS:	\$18.09	\$25.64

6. The following labor rates will apply to both **HHG and UB** shipments for points outside of CONUS (except Alaska):

SERVICE AREA	RATES \$	
	Per Man Hour	
	Regular (502A)	Overtime (502B)
Germany, Belgium, and Netherlands:	\$27.11	\$40.66
HAWAII: Islands of Hawaii & Oahu:	\$51.29	\$77.27
ALL OTHER POINTS OUTSIDE CONUS (for Alaska see below)	\$26.47	\$39.70

7. The following labor rates will apply to both **HHG and UB** shipments for Alaska:

	Note	RATES \$ Per Man Hour	
From 8:00 a.m. to 5:00 p.m. during Monday thru Friday of each week, EXCEPT on holidays:	(1)	\$72.73	(502A)
	(2)	\$69.67	(502A)
From 5:00 p.m. to 8:00 a.m. during Monday thru Friday of each week, and all hours on Saturday, EXCEPT on holidays:	(1)	\$87.34	(502B)
	(2)	\$82.97	(502B)
During all hours on Sunday and holidays:	(1)	\$108.91	(502C)
	(2)	\$103.90	(502C)

(1) Applicable ONLY to North of the Range as defined below:

NORTH OF THE RANGE TERRITORY - (Applicable ONLY when specific reference is made hereto). The rates and charges apply at points North of the Range, located in that portion of the State of Alaska on, connected to, or within mobile access of the state highway system, lying north or an imaginary line drawn between Denali Park (see Note 3) and Big Delta (Fort Greely), Alaska (including Denali Park and Big Delta (Fort Greely), Alaska.)

(2) Applicable ONLY to South of the Range as defined below:

SOUTH OF THE RANGE TERRITORY - (Applicable ONLY when specific reference is made hereto). The rates and charges apply at points South of the Range, located in that portion of the State of Alaska on, connected to, or within mobile access of the state highway system, lying south of an imaginary line drawn between Denali Park (see Note 3) and Big Delta (Fort Greely), Alaska.

Note: Denali Park is a station by that name on the Alaska Railroad.

Item 503 - Waiting Time

(503A) - Waiting Time: Vehicle

(503B) - Waiting Time: Labor (Regular)

(503C) - Waiting Time: Labor (Overtime)

(503D) - Waiting Time: Labor (Alaska)

1. This item will not apply when waiting time is the fault of the TSP. All charges in this section require pre-approval from the PPSO.
2. If the TSP or designated agent arrives at origin or delivery address and customer is not available, they should make an attempt to contact the customer prior to free time starting. If the customer cannot be contacted, the TSP or designated agent is required to contact the responsible JPPSO/PPSO to initiate the start of the required free time.
3. Use the applicable labor rates contained in Item 502 when billing
 - a. labor charges for the driver, and helper(s),
 - b. regular labor services under Item 503B,
 - c. overtime labor services under Item 503C, or
 - d. Sunday/holiday labor services (Alaska only) under Item 503D.
4. Loading and unloading or pickup and delivery will be performed during regular working hours.
5. Waiting time service is subject to the availability of the TSP to perform and is only applicable if requested and performed beyond the free waiting times indicated in this item.
6. Waiting time charges will be applicable only between regular working hours of 8 am to 5 pm local time at a rate of **\$30.61** (503A) per hour per vehicle less free waiting time.
7. Free waiting time by the responsible TSP or designated agent is required as follows:
 - a. 1-hour free waiting time for pick up at origin.
 - b. 1-hour free waiting time for direct deliveries.
 - c. 1-hour free waiting time for deliveries from SIT.
8. Charges based on time shall be computed in accordance with Item 502 paragraph 3.
9. TSPs may request waiting time in excess of free waiting time for base access delays when wait time exceeds 2 hours for shipments picking up from and/or delivering to a military installation. For delays exceeding 2 hours, a fee of \$75.00 (per instance) will apply and may be invoiced utilizing Item Code 533A (Misc. Charge) with a detailed note explaining the charge. An additional \$18.75 will apply in 15 min increments (i.e., 2 hours 15 min = \$93.75; 2 hours 30 min = \$112.50; 3 hours = \$150; 3 hours 30 min = \$187.50; 4 hours = \$225.00, 4 hours 15 min = \$243.75; 5 hours = \$300.00, etc.) (Note: this fee is only for base access delays). Upon notification from the TSP, PPSO/PPPOs will validate specific conditions at the affected installation (e.g., review force protection changes, physical choke points and delays associated with accessing the start of security checks, etc.).
 - a. Waiting time will not be authorized if delays are in any way due to TSP/agent actions.
 - b. Waiting time does not apply to port agents who pick shipments up from and/or deliver to the POE/POD.
 - c. This charge will only be authorized one time per shipment location (e.g., once at origin and once at destination). For example, if a TSP has a 3-day pack out and all 3 days the TSP/agent encounters long waiting lines, the TSP will only be paid for 1 day of waiting time the other days will not apply.

- d. Free waiting time at residence of up to 1 hour still applies.

Item 504 - Overtime Loading and Unloading

(504A) - Overtime Load/Unload - HHG

(504B) - Overtime Load/Unload - UB

1. Labor charges located in Item 502 will apply for each overtime loading or each overtime unloading when this service is performed other than during regular working hours and authorized and confirmed, in writing, by the PPSO.
2. Charges apply when the service is:
 - a. Performed other than during regular working hours when this service is made necessary by landlord requirements,
 - b. Required by prevailing laws or ordinances, or
 - c. Rendered at the specific request of the PPSO or its agent, made in writing, and the shipper or its agent is notified of the additional charge specified in this item for this service before the loading and/or unloading begins.
3. Charges will not apply when service is performed for TSP's convenience or when shipments are delivered to a warehouse at destination.
4. Services will be rendered only at the option of the TSP. Service at a warehouse must be agreed to by the warehouseman.
5. Other than regular working hours is defined as follows:
 - a. Between 5 p.m. and 8 a.m., except Saturdays, Sundays, and holidays.
 - b. During any hour on Saturday or Sunday.
 - c. During any hour on officially declared foreign national, U.S. national or state holidays, except such charges apply on state holidays ONLY when service is rendered within that state on such holiday.
6. The above provisions apply to HHG and UB except the charge for UB will be **\$20.29** (504B) per shipment for either a pickup or delivery. (Minimum weight has no bearing on UB.)

Item 505 - Reweighing

(505A) - Reweigh - HHG

(505B) - Reweigh - UB

1. TSPs must be cognizant of reweigh requests.
 - a. When requested by the PPSO/customer prior to the arrival of the shipment in DPS.
 - (1) Upon request, TSP must provide the customer and the responsible PPSO the time and specific location for each weighing to allow either party the opportunity to witness the reweigh.
 - (2) All DPS reweigh orders (DPS automatic reweigh e-mail, PPSO or customer request) are valid and should be complied with (see below exceptions):
 - a. Reweighs on HHG shipments weighing less than 500 lbs. are not authorized.

- b. Reweighs on UB shipments weighing less than 350 lbs. are not authorized unless the customer is near or has exceeded the authorized weight allowance.
2. TSP will be paid based on either valid weight tickets or a PPSO constructive weight of 7 lbs. per cu ft, whichever is less.
 3. Failure to perform a requested or automatic reweigh may result in administrative action (i.e., immediate suspension for non-performance of reweigh).
 4. Automatic Reweighs (pre-approval not required) – Tolerances as outlined below shall apply. TSPs will be required to automatically reweigh **shipments that meet any of the following criteria:**
 - a. All UB shipments weighing 500 pounds or more (i.e., CONUS to OCONUS, OCONUS to CONUS, and OCONUS to OCONUS).
 - b. HHG shipments for grades E-6 thru O-10, and DoD Civilians, weighing 7,000 pounds or more (i.e., CONUS to OCONUS, OCONUS to CONUS, and OCONUS to OCONUS).
 - c. HHG shipments for grades E-1 to E-5 weighing 4,000 pounds or more (i.e., CONUS to OCONUS, OCONUS to CONUS, and OCONUS to OCONUS).

Note 1: TSP/Agents (origin/destination) must coordinate reweighs and update DPS to mitigate duplication of reweighs (i.e., requested and automatic). To ensure accurate invoicing, if duplicate reweighs occur, TSP must update DPS with the lower of the of the net scale reweigh weights for HHG and the lower of the gross scale reweigh weights for UB. The lower of the reweigh weights will also be used to determine if a reweigh charge is applicable.

Note 2: When a reweigh is required, it must be performed at destination. When that is not possible, the reweigh may not be performed on the same scale as the original weighing of the shipment. The reweigh must be completed prior to delivery with sufficient time to allow the government or the customer an opportunity to witness the reweigh, if requested.

Note 3: For COS T and COS J shipments only, weight verification performed at the port agent's facility may be used for a reweigh requirement, unless the PPSO requests a reweigh on a shipment before delivery to the customer. If the requested reweigh is performed, the TSP must meet the threshold requirement to seek payment for the requested reweigh as outlined in Item 505.

5. Reweigh (Automatic or Required):
 - a. Origin Storage in Transit (SIT): If a shipment requires origin SIT, TSP may request SIT and perform the reweigh/witness reweigh at destination (if requested) prior to delivery or placement in SIT at Destination. While in storage, TSP may invoice for all storage costs and SIT additional days in 30-day increments.
 - b. Destination SIT: If a shipment requires destination SIT, TSP may request SIT and perform the reweigh/witness reweigh (if requested) prior to delivery or placement into SIT. While in storage, TSP may invoice for all storage costs and SIT additional days in 30-day increments.

- c. Direct Delivery: If a shipment is designated direct delivery, TSP must perform reweigh prior to delivery and cannot invoice for any services until reweigh has been performed and DPS reweigh information updated.
 - d. Reweighs will not be performed on the same scale. TSP will be required to invoice on the lesser weight if reweigh falls within the tolerances stated in this Tender.
6. TSP's Reweigh Refund Procedures:
- a. Reweigh refund will apply to all charges. TSP will submit refund(s) to the origin PPSO.
 - b. TSP will not be allowed to invoice for destination and/or direct delivery services until:
 - (1) the reweigh has been performed,
 - (2) reweigh information is updated in DPS,
 - (3) and reweigh tickets are provided to the origin PPSO.
 - c. If a refund is owed the refund will be submitted on the same invoice with the delivery out of SIT and/or direct delivery charges, etc.
 - (1) If refund is not submitted on the same invoice, destination PPSO will dispute or deny all destination and/or direct delivery charges until the refund has been submitted and processed for payment.
7. For additional reweighing guidance reference DTR Part IV, Chapter 402, Appendix B, and Tender of Service (TOS) available at <https://www.ustranscom.mil/dp3/pdfs.cfm>.

Reweigh (HHG):

1. The reweigh charge of **\$125.00** (505A) will apply to requested and automatic reweighs.
2. Reweigh charge shall be payable for both automatic and requested reweighs ONLY when one of the following apply:
 - a. The reweigh net scale weight is equal to or greater than the initial net scale weight.
 - b. The reweigh net weight is less than initial net weight and within the following tolerances:
 - (1) Shipments weighing 5,000 pounds or less; the initial net scale weight minus reweigh net scale weight is less than 150 pounds; or
 - (2) Shipments weighing more than 5,000 pounds; the initial net scale weight minus reweigh net scale weight is less than 5% of the lower net scale weight.
3. Reweigh charges do not apply on partial deliveries from SIT.
4. For shipments booked as COS 4/T/6, TSP may invoice a reweigh using only the "new gross weight" and the "origin tare weight" for containerized HHGs.
 - a. When the reweigh is performed before the shipment is placed into SIT or direct delivers, the TSP must always invoice on the lesser of the two weights.
 - (1) In order to determine whether to approve, dispute, deny, or require the TSP to re-bill services using a lower weight, PPSOs may calculate the new net weight determination as equal to the new gross minus the shipment original tare weight.

- (2) Subsequent completion of the reweigh (new tare weight) can be completed later with applicable follow-on supplemental invoice/reimbursements. If the new tare weight (reweigh tare weight) is:
 - (3) Less than the original tare weight, no additional monies are owed as the lower net scale weight will be used for determining applicable charges.
 - (4) Greater than the original tare weight AND exceeds the tolerance below, the TSP must reimburse the difference using Item Code LHSREF.
 - (a) If the tolerances are not exceeded, then no reimbursement is required.
 - (5) Reimbursement to the Government is required if the new tare weight is greater than the original tare weight and if the shipments weigh:
 - (a) 5,000 lbs. or less; the reweigh tare scale weight minus the initial tare scale weight is more than 150 lbs. overall; or
 - (b) Over 5,000 lbs.; the reweigh tare scale weight minus the initial tare scale weight is 5% or more than the overall lower tare scale weight.

Reweigh (UB):

1. The reweigh charge of **\$50.00** (505B) will apply to requested and automatic reweighs.
2. Reweigh charge shall be payable for both automatic and requested reweighs ONLY when one of the following apply:
 - a. The reweigh gross weight is equal to or greater than the initial gross weight.
 - b. The reweigh gross weight is less than the initial gross weight and the difference is less than 25 lbs.
3. For shipments placed in SIT prior to reweigh notification, the TSP may invoice based on the original origin weight.
 - a. TSP will reweigh shipment no later than the date of delivery from SIT.
 - b. If the reweigh weight is less than the original weight TSP must issue a refund to the origin PPSO based on the reweigh weight.
4. Reweigh charges do not apply on partial deliveries from SIT.

Item 506 - Debris Removal - HHG ONLY

(506A) - Debris Removal - HHG

1. This item requires pre-approval from the Government and is utilized by exception only as provided by Services guidance (e.g., Bluebark, etc.).
2. Debris Removal charges apply when the PPSO requests that the TSP perform debris removal of unpacked cartons after the date of delivery and the service is performed within 30 days of delivery date.
3. Debris Removal Service is **\$158.23** (506A) per shipment.
4. When debris removal is performed in conjunction with unpacking service, a debris removal charge will not apply.

Item 507 - Reserved for Future Use
Item 508 - Crates/Special Containers

(508A) - Crates Internal Minimum Charge

(508B) - Crates Internal

(508C) - Crates External

(508D) - Mbr Crates: Labor (Regular)

(508E) - Mbr Crates: Labor (Overtime)

(508F) - Mbr Crates: Labor (Sunday/Holiday – Alaska only)

1. All crating/containers billed under this item must be pre-approved by the PPSO, before any services are performed.
2. Crates will be constructed IAW SDDC Pamphlet 55-12 (Commercial Containers for Department of Defense (DoD) Household Goods Shipments).
3. Item 508A is subject to a minimum charge when billing for the construction of containers or crates that will fit into an SDDC approved HHG container (see ASTM-D-6251). Each crate/container must be billed separately.
4. If TSP utilizes a crate/container retained by the customer from a previous move, TSP may be compensated for labor to crate the item but will not be eligible to bill for the crate. See applicable rates under Item 502.
5. Crating is not recognized as a third-party service.
6. TSPs must annotate the actual dimensions of the item in their pre-approval request in DPS for internal and external crates and must bill either the actual cu ft of the crate, or the cu ft limitation in this item, whichever is less. No rounding of cubic dimensions is allowed. Number will be truncated at the second decimal. (e.g., 6.8055555 cu ft will be invoiced in DPS as 6.80 cu ft).
7. Crating of HHG may be authorized when standard packaging will not adequately protect an item from damage during transit.
 - a. TSPs should consider the type of movement when requesting crating. An item may require crating on a van shipment but may not need a crate in a containerized shipment.
 - b. Requirements for crating must be closely scrutinized to prevent unnecessary requests for crating.
 - c. Guidance on crating:
 - (1) TSP must use NEW material when crating is approved.
 - (2) When crating may be approved (including, but not limited to):
 - (a) External crating (Item 508C)
 - 1 Applies only to items that do not fit into an SDDC approved HHG container such as
 - a motorcycles,

- b mopeds,
 - c minibikes,
 - d scooters, etc.
- 2 Items that are unable to stand on their own or items of unusual nature that require additional protection for safe transit such as, but not limited to,
 - a hang gliders,
 - b sailboards, and
 - c hot tubs
- 3 If approved for crating, items that can stand alone are limited to a maximum of \$1,000 per crate (including, but not limited to):
 - a motorcycles with more than two wheels,
 - b ATVs,
 - c Jet Ski with trailer,
 - d trailers, etc.

(b) Internal crating (Item 508B):

- 1 Applies to items that require additional protection for safe transit IAW SDDC Pamphlet 55-12 (Commercial Containers for Department of Defense (DoD) Household Goods Shipments).
- 2 Only those items that have unique features will be approved for crating. Features such as leaded glass or curved glass panels that cannot be duplicated without great expense could be justification for crating.
- 3 Items such as marble tabletops and pool table slates (when not included in a third-party service) may be too heavy or large for available cartons and are eligible for crating.
- 4 TVs: Crating charges may only apply to flat/curved screen television in excess of a 75-inch diagonal screen size.

(3) When crating may NOT be approved:

- (a) Crating items such as rugs, sofas, tables, chairs, buffets, grandfather clocks, and other like items, unless there are unique features easily susceptible to damage.
- (b) A customer's request to crate items declared to be of extraordinary value but lacks appraisal and/or is missing features that cannot be duplicated without great expense.
- (c) Flat/curved screen televisions with a 75-inch diagonal screen size or less.
 - 1 No additional compensation will be provided for flat/curved screen television cartons or containers.

Item 509 - Extra Pickup or Delivery

(509A) - Extra Pickup - HHG

(509B) - Extra Pickup - UB

(509C) - Extra Delivery - HHG

(509D) - Extra Delivery - UB

(509E) - Extra Pickup/Delivery: Labor (Regular)

(509F) - Extra Pickup/Delivery: Labor (Overtime)

(509G) - Extra Pickup/Delivery: Labor (Sunday/Holiday – Alaska only)

(509H) - Extra Pickup over 100 miles

(509I) - Extra Delivery over 100 miles

1. Rate is based upon a flat rate plus mileage rates when billing for extra pickup or delivery services for HHG shipments under Items 509A, 509C, 509H, and 509I, respectively. Each extra pickup or delivery should be billed separately.
2. Rate is based upon a flat rate only when billing for extra pickup or delivery services for UB shipments under Items 509B and 509D respectively.
3. Use the applicable labor rates contained in Item 502 when billing for regular labor services under Item 509E, overtime labor services under Item 509F, or Sunday/holiday labor services (Alaska only) under item 502C.
4. Portions of a shipment may be picked up or delivered at one or more places, origins, destinations, or enroute, provided all portions of the shipment are made available to the TSP at the same time. Service under this item will be authorized by proper entry on the BL or by ordering of service and certification on DD Form 619 by the responsible PPSO.
5. When the Primary Pickup (Block 19) or Delivery (Block 18) is a commercial warehouse rented by the customer, the TSP is required to enter the facility, at no additional cost to service the shipment.
6. If the DoD customer requests an additional pickup or delivery at a commercial warehouse rented by the customer, labor rates may apply with PPSO pre-approval.
7. Charges for Extra Pickup or Delivery of UB will be an additional charge of **\$24.36** (509B & 509D) per extra pickup or delivery per shipment will apply.
8. Charges for extra pickup or delivery of HHG will be computed as follows:

Contiguous United States And Hawaii	Overseas, Excluding Alaska And Hawaii	Alaska
509A and/or 509C	509A and/or 509C	509A and/or 509C
Flat Rate	Flat Rate	Flat Rate
\$65.44 Per Extra Pickup/Delivery	\$41.20 Per Extra Pickup/Delivery	\$97.41 Per Extra Pickup/Delivery

9. For additional pickups/deliveries of HHG more than 100 miles from origin/destination, the TSP shall bill the following, in addition to the flat rate specified above:

Contiguous United States And Hawaii	Overseas, Excluding Alaska And Hawaii	Alaska
509H and/or 509I	509H and/or 509I	509H and/or 509I
\$.28 cents per cwt per 10-mile increment or fraction thereof (over 100 miles)	\$.28 cents per cwt per 10-mile increment or fraction thereof (over 100 miles)	\$.72 cents per cwt per 10-mile increment or fraction thereof (over 100 miles)

Example: TSP is ordered to perform an extra pickup for a 12,000 lbs. HHG shipment located 125 miles from origin within CONUS, the TSP shall bill \$100.80 $[(.28*120)*3]$ plus \$65.44 for total of \$166.24.

Item 510 - Attempted Delivery to Residence from SIT

(510A) - Attempted Delivery-SIT: 1-50 mi - HHG

(510B) - Attempted Delivery-SIT: 1-50 mi - UB

(510E) - Attempted Delivery-SIT: Outer Islands of Hawaii - UB

(510F) - Attempted Delivery-SIT: Warehouse Handling - HHG

(510G) - Attempted Delivery-SIT: Warehouse Handling - UB

(510I) - Attempted Delivery-SIT: Waiting Time (Vehicle)

(510J) - Attempted Delivery-SIT: Labor (Regular)

(510K) - Attempted Delivery-SIT: Labor (Overtime)

(510L) - Attempted Delivery-SIT: Labor (Sunday/Holiday – Alaska only)

1. Attempted delivery will normally NOT APPLY as deliveries are usually arranged directly between the TSP and customer.
 - a. In DPS, the TSP is responsible to make direct contact with the customer.
 - b. Only in circumstances where the delivery date in question was scheduled by the PPSO or confirmed by the PPSO to be the customer's fault, may the TSP request attempted delivery.
2. Once the TSP and customer have agreed to a delivery date,
 - a. the TSP MUST update DPS with a scheduled delivery date prior to the actual delivery date or within 2 hours after agreeing to a delivery date/time with the customer, whichever is earlier.
 - b. If a TSP fails to enter the scheduled delivery date in DPS the PPSO will have grounds for disapproval of any attempted delivery charge, even if the delivery was scheduled by the PPSO.
3. Only in circumstances where attempted delivery is authorized (see paragraph 1), then it requires pre-approval while at residence. If a TSP arrives at delivery point and cannot locate the customer or an authorized representative,

-
- a. TSP must contact the PPSO while at the delivery point to request pre-approval of an attempted delivery.
 - b. PPSO will have one hour of free waiting time from the time they are contacted to locate the customer/representative or to approve/disapprove the attempted delivery.
4. Compensation for attempted delivery to residence from SIT when failure to deliver is not the fault of the TSP will be as follows:
- a. Round trip mileage from the warehouse to residence and return.
 - (1) If total mileage is 50 miles or less, Delivery Transportation Rate on SIT shipments will apply.
 - (2) If total mileage is greater than 50 miles, applicable provisions of Item 520/521 will apply.
 - (3) The provisions and rates for delivery from SIT under Item 520 apply when billing round trip mileage from the warehouse to residence and return for a HHG shipment under Item 510A.
 - (4) The provisions and rates for delivery from SIT under Item 521 apply when billing round trip mileage from the warehouse to residence and return for a UB shipment under Item 510B or 510E.
 - b. Warehouse Handling:
 - (1) The warehouse handling rates under Item 518 apply when billing warehouse handling services for a HHG shipment under Item 510F.
 - (2) The warehouse handling rates under Item 519 apply when billing warehouse handling services for a UB shipment under Item 510G. Item 510G is subject to a minimum charge.
 - (3) If the shipment is placed into SIT again
 - (a) a second warehouse handling charge will apply unless the shipment remains on the vehicle until delivered, in which case, the additional warehouse handling charge will not apply,
 - (b) the same SIT control number will apply, and
 - (c) storage charges will continue at the additional daily rate.
 - c. Waiting Time: The provisions of Item 503 will apply if TSP is required to wait at residence past the 1-hour free waiting time. The hourly vehicle rates located under Item 503 apply when billing for waiting time under Item 510I.
 - d. Use the applicable labor rates contained in Item 502 when billing for regular labor services under Item 510J, overtime labor services under Item 510K, or Sunday/holiday labor services (Alaska only) under item 502C.
5. If a delivery from SIT is cancelled and the TSP's agent has performed services in preparation for the delivery
- a. labor charges are authorized in accordance with the rates set forth in the Tender.

- b. the PPSO should determine at the time of cancellation if services were performed. If services have been performed, the PPSO must determine the applicable charges.

Item 511 - 512 - Reserved for Future Use**Item 513 - Fuel Surcharge (CONUS, Including Alaska, and Hawaii)**

(513A) - Fuel Surcharge-LHS

(513B) - Fuel Surcharge-Delivery to/from SIT

1. The Fuel Surcharge applies to commercial TSP Personal Property (PP) movements within the Continental United States (CONUS), Alaska, and Hawaii.
2. This provision shall apply only to any inland transportation segment within CONUS where a Fuel Surcharge applies to that segment of a shipment transported via domestic linehaul.
 - a. 513A - The fuel surcharge rate to apply to the domestic linehaul portion of the shipment based on the actual origin pickup date and is the prevailing rate.
 - b. 513B - The fuel surcharge rate to apply to the domestic linehaul portion of the shipment for shipments delivering into SIT domestically is the prevailing rate for the requested pickup date at time shipment was offered and accepted.
 - c. 513B - The fuel surcharge rate to apply to the domestic linehaul portion of the shipment for shipments delivering out of SIT domestically is the prevailing rate for the actual delivery date.
3. The code identified for FSC billing is an authorized ANSI code.
 - a. Fuel price adjustments will be clearly shown on all paper and electronic BL and invoices.
 - b. The amount of any diesel fuel rate surcharge must be shown as a separate item on the TSP's invoice.
4. Rates submitted must be all-inclusive. USTRANSCOM will not pay Fuel Related Adjustments (FRA) on
 - a. "Spot bid" or One-Time-Only (OTO) personal property movements; regardless of mode,
 - b. Rail,
 - c. Barge,
 - d. Pipeline,
 - e. Air shipment, or
 - f. Third-party service.
5. USTRANSCOM shall pay the TSP 1% (one percent) of the linehaul rate for every increment of \$.13 (thirteen cents) by which the fuel cost exceeds \$3.50 at the time of actual pickup.
6. FRA entitlement will be determined by the national average diesel fuel price published on the first Monday of the month (or the first business day after a Monday if the Monday falls on a federal holiday) by the Department of Energy (DOE) and Energy Information Administration (EIA). The diesel fuel prices published by the EIA may be found at:
 - a. EIA Website: <https://www.eia.gov/petroleum/gasdiesel/>

“U.S. On-Highway Diesel Fuel Prices”

b. EIA Hotline: (202) 586-6966

7. Calculating FSC:

a. Utilize applicable rate in the Item 530 Linehaul Rate Schedules based on DTOD mileage from

pickup address to port used

port used to final delivery address

pickup address to origin SIT warehouse

origin SIT warehouse to port used

port used to destination SIT warehouse

destination SIT warehouse to final delivery address

b. Utilize Fuel Related Rate Adjustment in effect per paragraph 2a., b., or c. above.

c. Multiply the applicable linehaul rate x weight of the shipment x applicable Fuel Related Rate Adjustment = FSC amount invoiced.

8. The USTRANSCOM Personal Property Fuel Surcharge (FSC) Table is available at <https://www.ustranscom.mil/dp3/pdfs.cfm>.

a. The table below demonstrates the percentage of the line-haul rate USTRANSCOM will pay at a given fuel cost given a \$3.50 baseline. Should the baseline differ at any time, the same principle applies simply with a different starting point for calculating the percent adjustment. The table ends at \$6.51, but the same principle applies to fuel costs above that dollar amount.

b. For example, if the reported EIA National Average diesel fuel price is \$5.15 the TSP would be entitled to an FRA of 12% of the line-haul rate.

From	To	FRA
\$3.50 and below		Percentage
\$3.50	\$3.63	1%
\$3.63	\$3.76	2%
\$3.76	\$3.89	3%
\$4.04	\$4.17	4%
\$4.17	\$4.30	5%
\$4.30	\$4.43	6%
\$4.43	\$4.56	7%
\$4.56	\$4.69	8%
\$4.69	\$4.82	9%
\$4.82	\$4.95	10%
\$4.95	\$5.08	11%

\$5.08	\$5.21	12%
\$5.21	\$5.34	13%
\$5.34	\$5.47	14%
\$5.47	\$5.60	15%
\$5.60	\$5.73	16%
\$5.73	\$5.86	17%
\$5.86	\$5.99	18%
\$5.99	\$6.12	19%
\$6.12	\$6.25	20%
\$6.25	\$6.38	21%
\$6.38	\$6.51	22%

Item 514 - Government-Owned Containers (GOCs)

1. When the TSP is out of containers and cannot or refuses to purchase them locally,
 - a. TSPs will be required to accept usable GOCs offered by the PPSO.
 - b. Failure to accept GOC may result in placement of TSP in non-use into and out of the rate area concerned.
2. Reporting of GOCs
 - a. The TSP must notify the destination PPSO at the time of notification of arrival when the shipment contains a GOC.
 - b. TSP must report GOCs by container number to the destination PPSO upon notification of delivery.
3. GOC usage
 - a. TSP may use GOCs to transport BL shipments when containers are made available by the PPSO. When a TSP uses GOCs,
 - (1) a reduction of **\$45.00** for each container of 166 cu ft or greater will apply to the shipment. Invoice utilizing Item Code 533A Miscellaneous Charge.
 - (2) the BL will be annotated as follows:
 - (a) "(Number of) containers, 166 cu ft or greater, were used to transport shipment. \$(Amount) reduction applies to shipment."
 - b. Use the applicable labor rates contained in Item 502 when billing regular labor services, overtime labor services, or Sunday/holiday labor services (Alaska only).
4. Returning GOCs
 - a. If either the destination residence or TSP's facility is within a 10-mile radius of the destination PPSO turn-in point, GOCs will be returned by the TSP to Government control without cost to the Government.

- b. If the turn-in point is beyond a 10-mile radius, disposition instructions will be issued by the destination PPSO. Charges will be computed based on the Auxiliary Services for per hour, per vehicle under Item 501.

Item 515 - Reserved for Future Use

Item 516 - Shipping Procedures for the Hawaiian Islands

(516A) - Outer Hawaiian Islands (via Oahu) - Vehicle Hours

(516B) - Outer Hawaiian Islands (via Oahu) - Labor (Regular)

(516C) - Outer Hawaiian Islands (via Oahu) - Labor (Overtime)

1. For shipments from/to the Island of Oahu, the SFR for US89 applies.
2. For shipments that are misconsigned or customer is reassigned, and shipment is transported to a neighbor island, TSPs will be authorized additional labor, vehicle, and water/air charges.
 - a. Charges for vehicle and labor will be in accordance with rates set forth in Items 501 and 502.
 - b. To substantiate payment, a certified DD Form 619 and OBL or airway bill for UB shipments must be submitted to the appropriate finance and accounting office with the TSP's payment invoice.
3. Shipments from/to the neighbor Islands of Oahu (Kahoolawe, Kauai, Lanai, Maui, Molokai, Niihau, and the Island of Hawaii (Big Island)), will be handled under the OTO program, see Item 1302.

Item 517 - Shipping Procedures for the Florida Keys

(517A) - Service Charge: Florida Keys

1. Applies to HHG shipments only. For pickup or delivery of shipments from/to the Florida Keys, the SFR for US4965500 plus **\$12.38** (517A) per net cwt charge will apply.
2. Shipments transported from or to Zip3 of 330 will be subject to a Florida Keys Service Charge.

Item 518 - SIT and Warehouse Handling Charges - HHG

(518A) - SIT Additional Day - CONUS

(518B) - SIT 1st Day and Warehouse Handling - CONUS

(518C) - SIT 1st Day and Warehouse Handling - OCONUS

(518D) - SIT Additional Day - OCONUS

1. All SIT and related charges are in dollars and cents per net cwt and apply based on location listed on Block 18 for destination SIT and Block 19 for origin SIT of the BL unless otherwise authorized by the PPSO. Charges for these services will be based on actual net weight of goods stored in transit, subject to a 500 lbs. minimum. Rates in effect on the date of actual pickup at origin will apply.

2. SIT of property is the holding of the shipment, or portion thereof, in the DoD approved facility or warehouse used by the TSP or its agent for storage, pending further transportation, and will be affected only at specific request of the shipper or under the conditions specified below. Subject to PPSO approval, the TSP may use any DoD-approved SIT facility/warehouse listed in DPS.
3. The TSP shall include the substance of this clause, including the requirement to further flow down the clause, in all subcontracts for/or subcontractors supporting storage under this Tender.
4. A shipment or portion thereof may be placed in SIT one or more times for an aggregate period not to exceed storage authorized as specified from the PPSO.
5. This Item applies when an automated SIT Control Number is issued by DPS to the requesting TSP, authorized agent, or the responsible PPSO validates and authorizes an automated SIT Control Number.
 - a. Storage charges apply for each day of storage and apply each time SIT service is rendered. Storage days will include the day goods are placed in storage and the day goods are removed from storage.
 - b. See Tender of Service for 24-hour Notification process.
6. When a shipment is placed in SIT in CONUS, the TSP agrees to the following:
 - a. Storage. The warehouseman shall have until the close of business of the third (3rd) working day following the date the SIT control number is issued to complete the handling-in services. Personal property shall be stored so as to protect it from loss and damage.
 - b. Shipping Container. Contents of containerized shipments will not be removed from containers when placed in SIT.
 - c. Identification. All lots of loose HHG, storage lots, and non-containerized HHG and UB shipments shall be properly identified.
7. Tender of Delivery of Containerized Shipments:
 - a. TSP must arrive shipment in DPS, then provide at least 24-hour notice to the customer before placing shipment in SIT. For further guidance on 24-hour notice see the Tender of Service.
8. SIT, when approved, will always be effective on the TSP's first available delivery date, not the date of notification (SIT Control Number will be equal to the TSP's first available delivery date, not the date of notification).
9. It is the TSP's responsibility to meet customer expectations for direct deliveries on shipments with delivery addresses entered in DPS at the time the TSP accepted the shipment.
10. Delivery to residence should be made on the date requested, if possible. If prior commitments prevent delivery on that date, (every effort should be made to deliver as soon as possible thereafter within 5 working days after the requested delivery date). In any event, storage charges shall cease to accrue on either of the following dates, whichever is earlier:

-
- a. Requested delivery date, or 5 working days following notification, whichever is later, or
 - b. Date of actual delivery for CONUS locations, or the date immediately prior to the date of actual delivery for overseas locations.
11. The PPSO will notify TSP of the
- a. extension (in DPS and/or writing) and
 - b. projected termination date.
12. The transportation rates to apply on shipments stored in transit (exclusions apply to below such as changes prior to pickup and diversions).
- a. Origin SIT is based on the original requested pickup address (Block 19 of the BL) at time shipment is offered and accepted by TSP, not the warehouse location.
 - b. Destination SIT is based on the original requested delivery address (Block 18 of the BL) at time shipment is offered and accepted by TSP, not the warehouse location.
- (1) At ORIGIN ONLY will be:
- (a) Item(s) 520/530 pickup transportation rate from the original requested pickup address (Block 19 of the BL) at the time the shipment is offered and accepted by the TSP, not the warehouse location.
 - (b) The SFR from the original requested pickup address (Block 19 of the BL) to the original requested delivery address (Block 18 of the BL) at the time the shipment is offered and accepted by the TSP, not the warehouse location.
- (2) At BOTH ORIGIN and DESTINATION will be:
- (a) Item(s) 520/530 pickup transportation rate from the original requested pickup address (Block 19 of the BL) at the time the shipment is offered and accepted by the TSP, not the warehouse location.
 - (b) The SFR from the original requested pickup address (Block 19 of the BL) to the original requested delivery address (Block 18 of the BL) at the time the shipment is offered and accepted by the TSP, not the warehouse location.
 - (c) Item(s) 520/530 delivery transportation rate from the original requested delivery address (Block 18 of the BL) at the time the shipment is offered and accepted by the TSP, not the warehouse location, to final destination point.
- (3) At DESTINATION ONLY will be:
- (a) Item(s) 520/530 delivery transportation rate from the original requested delivery address (Block 18 of the BL) at the time the shipment is offered and accepted by the TSP, not the warehouse location, to final destination point, regardless if shipment crosses state lines and/or country borders.
 - (b) The SFR from the original requested pickup address (Block 19 of the BL) to the original requested delivery address (Block 18 of the BL) at the time the shipment is offered and accepted by the TSP, not the warehouse location.
13. Split Shipment:

- a. Except as specifically provided for herein, each portion of the shipment will be rated at the applicable rate in effect on the date of pickup of each portion, based on total weight of the entire shipment.
- b. On property consigned to SIT wherein an overflow of property requires that a split shipment be delivered to the storage facility on different dates, the charges for such property will be as follows:
 - (1) Transportation charges from initial point of pickup to storage location will be based on the combined weight of the property stored in transit, and computation of transportation charges will be as provided in this item.
 - (2) Storage charges in effect on date of actual pickup will be assessed separately on each portion of shipment stored in transit.
 - (a) Minimum weight, as outlined in Item 201, does not apply to each portion of split/partial shipments but will apply to the combined weight of property stored in transit.
 - (b) Storage will be rated separately on each portion added.
 - (3) Warehouse handling charge will apply only once, based on the combined weight of the property stored in transit.
 - (4) All subsequent charges will be based on the combined weight of the property stored in transit.
- c. When property is placed in SIT, in segments, on different dates:
 - (1) The transportation rates and additional service charges in effect on the date of actual pickup of the first segment will apply to that segment only.
 - (2) The transportation rates and additional service charges in effect on the date(s) of actual pickup of each subsequent segment placed in SIT will apply to these subsequent segments.

14. Partial withdrawal (delivery) from SIT:

- a. During SIT, the shipper or customer may request withdrawal of a portion of the property. The customer must contact the PPSO and the PPSO will arrange with the TSP to schedule a partial delivery out so that all entitlements can be verified, and preapprovals entered into DPS for labor, except as provided in the DTR Chapter 402.
 - (1) Inventory item numbers will be furnished by the customer to the TSP/PPSO. PPSO will, in turn, order the service.
 - (a) Items for withdrawal should be indicated at the time of packing when possible.
 - (b) Only complete cartons or item numbers on the inventory may be withdrawn. Individual cartons will not be opened.
 - (2) When the selection of items requires unstacking and/or restacking of the shipment or a portion of the shipment, charges for such handling will be assessed in accordance with labor charges (see Item 502 for applicable rates).

-
- (3) The customer or Government representative will have the right to be present at the TSP's facility during the sorting of the property. The TSP will deliver, or the customer has the option to pick up the property.
 - (4) TSP is responsible for obtaining actual weight of portion withdrawn.
 - (5) Charges for transportation furnished, if any, for portion selected for delivery will be assessed on the same basis as would apply to that portion as an individual shipment.
- b. The following will be applicable to the portion remaining in storage.
- (1) Charges for transportation furnished, if any, for the delivery of the remainder of the property will be assessed on the same basis as would apply to that portion as an individual shipment.
 - (2) Storage charges will continue to apply on the weight of the remainder of the property.
15. During the SIT period, customer may not add property to those already in SIT.
16. If delivery cannot be made at the address specified on the BL because of impractical operations as defined herein, or for any other reason other than the fault of the TSP, and neither PPSO nor customer designates another address where delivery can be made, TSP will place the property in SIT.
17. When property is removed from SIT and extra pickups are ordered the transportation rates and additional service charges in effect on the date the
- a. extra pickup is performed will apply to the entire weight of the extra pickup, and
 - b. actual pickup of the SIT portion will apply to the entire weight of that portion.
18. See State GBLOC Item 500 Table, Geographical Application of Rates and Schedules, for SIT and Warehouse Handling Rate to apply when service is performed at points within CONUS (other than points listed below). Rates apply in the territory or at the points shown below based on the location (Block 18 for Destination SIT and Block 19 for Origin SIT).

SIT and Warehouse Handling Charges by Location - HHG

Overseas area	1st Day of SIT and Warehouse Handling NWCT (518C)	EA Additional Day NWCT (518D)
Alaska	\$7.88	\$0.27
Argentina	\$12.39	\$0.36
Australia	\$7.88	\$0.13
Belgium, Crete, Spain, Turkey & all other European countries not otherwise provided	\$12.98	\$0.37
Brazil	\$7.07	\$0.19
Canada	\$4.54	\$0.09
Chile, Colombia, Costa Rica, Ecuador, El Salvador	\$4.45	\$0.12
Germany	\$8.88	\$0.25
Guam	\$9.28	\$0.28
Guatemala, Honduras, Peru & Venezuela	\$5.68	\$0.16
Hawaii	\$9.28	\$0.28
Iceland	\$9.08	\$0.25
Italy, Sicily & Sardinia	\$5.51	\$0.15
Japan - Central (JA01)	\$5.71	\$0.19
Japan - South (JA02)	\$5.48	\$0.16
Japan - North (JA03)	\$5.14	\$0.17
Okinawa (JA96)	\$4.35	\$0.15
Korea, Philippines & Subic Bay	\$7.29	\$0.17
Netherlands	\$7.91	\$0.18
Puerto Rico	\$7.56	\$0.20
United Kingdom	\$7.93	\$0.27
Uruguay	\$4.67	\$0.12
Any geographic locations other than those listed above (including autonomous regions - e.g., Azores)	\$4.24	\$0.10

19. Shipments converted to customer's expense:

- a. Storage is subject to the Servicemembers Civil Relief Act and applicable state, local and bailment laws, and regulations.
- b. When a shipment is not removed from SIT during the authorized storage period by the customer, the PPSO will contact the customer NLT 30 calendar days before storage expiration to determine if the customer will require additional storage. If PPSO

determines the customer is not authorized additional storage the PPSO will advise the customer of the last day of storage and perform the following actions:

- (1) Convert shipment to customer's expense in DPS. TSPs liability for that BL shall terminate at midnight of the last day authorized by the PPSO.
- (2) TSP or warehouseman will receive notice from the PPSO (in DPS and/or in writing) that the entitlement for additional days of storage at government expense has ended and the customer is responsible for payment of additional days of storage to the warehouseman until shipment is delivered.
- (3) The warehouseman will become the agent for the shipper, until shipment is delivered.
- (4) The Government will pay the TSP for all SIT costs, up to and including the day of termination.
- (5) At the request of the customer, and after all applicable storage charges owed by the customer are paid to the warehouseman, PPSO will arrange for the delivery out services. Delivery out services will be paid by the Government.
- (6) All delivery charges will be paid to the delivering entity on a local voucher submitted to the PPSO using current Item 520 rates based on the delivery date of the shipment and any other associated charges authorized by the PPSO.

Item 519 - SIT and Warehouse Handling Charges - UB

(519A) - SIT 1st Day and Warehouse Handling

(519C) - SIT Additional Day

1. SIT of UB will be handled under the same rules that apply to HHG with the following exceptions:
 - a. SIT and warehouse handling charges are in dollars and cents per gross cwt and apply based on location listed on Block 18 for Destination SIT and Block 19 for Origin SIT of the BL. Charges for these services will be based on actual weight of goods stored in transit, subject to a 350 lbs. (gross) minimum. Rates in effect on the date of actual pickup at origin will apply.
 - b. Shipments weighing 250 lbs. or less may be delivered direct and the PPSO notified within 48 hours of delivery.
 - c. TSP must notify the PPSO of arrival of a shipment within 1 working day after arrival at the agent's facility by arriving the shipment in DPS.
 - d. Delivery to residence should be made on the date requested, if possible. If prior commitments prevent delivery on that date, (every effort should be made to deliver as soon as possible, subject to the following:
 - (1) If the shipment is not removed from storage by the 3rd working day (excluding Saturday, Sunday, and Holidays) after the requested delivery date(s), storage charges will cease to accrue after such date.

- (2) If the shipment is removed from storage prior to the 3rd working day after the requested delivery date(s), storage charges will cease to accrue the day the shipment is removed.
- (3) Date of actual delivery for CONUS locations or the date immediately prior to the date of actual delivery for overseas locations, storage charges will cease to accrue after such date.

SIT and Warehouse Handling Charges by Location - UB

When Warehouse is Located At:	1ST Day of SIT and Warehouse Handling - Per Gross cwt (519A)	SIT Each additional day - Per Gross cwt (519C)
Any point within CONUS	\$8.41	\$0.33
OVERSEAS:		
Alaska (All Zones)	\$8.92	\$0.41
Australia	\$9.50	\$0.38
Belgium	\$8.15	\$0.41
Germany	\$9.64	\$0.51
Hawaii/Guam	\$9.64	\$0.27
Japan - Central (JA01)	\$7.38	\$0.43
Japan - South (JA02)	\$7.50	\$0.43
Japan - North (JA03)	\$6.55	\$0.31
Okinawa (JA96)	\$6.88	\$0.33
Korea	\$7.87	\$0.38
Netherlands	\$8.82	\$0.42
Norway	\$8.53	\$0.43
Puerto Rico	\$8.31	\$0.43
Scotland/United Kingdom	\$9.59	\$0.49
Any geographic locations other than those listed above (including autonomous regions (e.g., Azores))	\$6.11	\$0.25

Item 520 - Pickup or Delivery Transportation Rates to Apply on SIT Shipments – HHG

- (520A) - SIT Pickup/Delivery - HHG
- (520B) - SIT Pickup/Delivery: over 50 miles - HHG (CONUS)
- (520C) - SIT Overtime Load/Unload - HHG
- (520D) - SIT Pickup/Delivery: over 50 miles - HHG (OCONUS)

1. The applicable rate is based on mileage and location as described in this item when billing pickup or delivery services under Item 520A. Use the applicable HHG rate contained under Item 504 when billing overtime loading and unloading services under Item 520C.
2. Rates in this item apply to shipments stored at either Commercial or Government facilities and to drayage of SIT shipments as follows:
 - a. From the original requested pickup address (Block 19 of the BL) at time shipment is offered and accepted by TSP, not the warehouse location.
 - b. From the original requested delivery address (Block 18 of the BL) at time shipment is offered and accepted by TSP, not the warehouse location.
3. For shipments that are released to the dock
 - a. TSP is not authorized charges under Item 520,
 - b. TSP shall submit a pre-approval for labor (Item 502) for placing items on dock,
 - c. If TSP plans to assist the customer with loading their vehicle, TSP may submit a pre-approval for labor (Item 502), and
 - d. TSP will refund **\$3.87** cwt for non-performance of unpacking under Item 522D SFR Reduction.
4. For shipments converted to customer's expense

TSP will refund **\$3.87** cwt for non-performance of unpacking under Item 522D SFR Reduction. Delivering entity may invoice **\$3.87** for unpacking (if performed) on a local voucher submitted to the PPSO.
5. For shipments releasing from non-temporary storage,

TSP will refund **\$6.45** cwt for non-performance of packing under Item 524C SFR Reduction.
6. Shipments stored within CONUS:
 - a. Pickup or delivery within a 50-mile driving radius of pickup or delivery location requested at the time the shipment is offered and accepted by TSP (designated in Block 19 or Block 18 of the BL); rates in applicable schedule apply.
 - b. Pickup or delivery beyond a 50-mile driving radius of the location requested at the time the shipment is offered and accepted by TSP (designated in Blocks 19 or Block 18 of the BL), apply applicable schedule, plus rate for additional mileage beyond 50 miles, as contained in the Item 530 Linehaul Rate Schedules. The combined cost is billed under Item 520B.
 - c. Item 520 does not require pre-approval from the Government unless the following situations exist:
 - (1) Delivery out of SIT is greater than 100 miles,
 - (2) The customer has amended orders changing their assignment to a new gaining organization, unit/company, or installation that is outside of the original destination rate area/region and/or over 100 miles (using DTOD miles).

-
- d. If a PPSO does not acknowledge a delivery address change request before the scheduled delivery date, the TSP shall deliver the shipment to meet the customer's expectation.
 - e. If the address is over 100 miles from Block 18 of the BL, the TSP will not schedule delivery out of SIT until the approval has been entered in DPS.
7. Shipments stored within OCONUS:
 - a. apply the applicable Schedule rate and invoice using Item Code 520A.
 - b. for additional mileage beyond 50 miles (if applicable), apply the rate as contained in the Item 530 Linehaul Rate Schedules and invoice using Item Code 520D.
 - c. The break point is the weight at which the use of the minimum weight and applicable rate table of the next higher weight bracket becomes cost favorable.
 8. Shipments that require further movement to or through one or more OCONUS rate areas will be authorized for a diversion (Item 526) or termination (Item 522/523).
 9. Shipment(s) that are terminated at the SIT facility and reshipped will be IAW Item 524/525.
 10. Long Delivery out of SIT (greater than 50 miles):
 - a. may not be used for shipments requiring further over-ocean movement
 - b. If PPSOs request a long delivery out of SIT within the same OCONUS rate area, but not requiring over-ocean movement,
 - (1) the TSP will agree to deliver the shipment under the same BL that brought the shipment into SIT,
 - (2) no additional documentation will be provided, and
 - (3) the TSP will bill the additional transportation charge in accordance with rates in Item 530 (Linehaul Rate Schedules) and invoice using Item Code 520D.
 11. The PPSO may order, subject to the TSP's concurrence, the services provided by this item during other than regular working hours.
 12. The rates specified below plus overtime loading and/or unloading charges will apply.
 - a. These additional charges will not apply when service is performed for the convenience of the TSP.
 - b. When such service is ordered, it must be confirmed in writing.
 - c. Rates in effect on date of actual pickup at origin will apply.
 13. See State GBLOC Item 500 table, Geographical Application of Rates and Schedules for Pickup or Delivery Transportation Schedules to apply when service is performed at points within CONUS.

Pickup or Delivery Transportation Rate Schedules:

	WEIGHT RANGE		BREAK POINT WT (lbs.)	RATE (net cwt)
SCHEDULE A:	500	999	588	31.47
	1000	1999	1,685	18.50
	2000	3999	3,410	15.58
	4000	and over		13.28
SCHEDULE B:	500	999	559	35.55
	1000	1999	1,681	19.86
	2000	3999	3,513	16.69
	4000	and over		14.66
SCHEDULE C:	500	999	574	37.35
	1000	1999	1,686	21.41
	2000	3999	3,603	18.05
	4000	and over		16.25
SCHEDULE D:	500	999	587	40.18
	1000	1999	1,657	23.57
	2000	3999	3,561	19.52
	4000	and over		17.38
SCHEDULE E:	500	999	595	43.46
	1000	1999	1,605	25.83
	2000	3999	3,700	20.73
	4000	and over		19.17
SCHEDULE F:	500	999	610	46.50
	1000	1999	1,616	28.33
	2000	3999	3,471	22.89
	4000	7999	7,724	19.86
	8000	and over		19.17
SCHEDULE G:	500	999	628	49.08
	1000	1999	1,612	30.78
	2000	3999	3,383	24.81
	4000	7999	7,311	20.98
	8000	and over		19.17

	WEIGHT RANGE		BREAK POINT WT (lbs.)	RATE (net cwt)
SCHEDULE H:	500	999	629	52.69
	1000	1999	1,620	33.12
	2000	3999	3,300	26.83
	4000	7999	6,931	22.13
	8000	and over		19.17

SCHEDULE I:	500	999	633	56.17
	1000	1999	1,620	35.55
	2000	3999	3,276	28.79
	4000	7999	6,506	23.57
	8000	and over		19.17

SCHEDULE J:	500	999	642	59.98
	1000	1999	1,613	38.48
	2000	3999	3,243	31.02
	4000	7999	6,568	25.15
	8000	and over		20.64

SCHEDULE K:	500	999	651	63.50
	1000	1999	1,605	41.29
	2000	3999	3,254	33.12
	4000	7999	6,539	26.94
	8000	and over		22.02

SCHEDULE L:	500	999	665	65.18
	1000	1999	1,622	43.31
	2000	3999	3,205	35.10
	4000	7999	6,584	28.12
	8000	and over		23.14

SCHEDULE M:	500	999	650	67.89
	1000	1999	1,606	44.12
	2000	3999	3,251	35.42
	4000	7999	7,303	28.79
	8000	and over		26.28

	WEIGHT RANGE		BREAK POINT WT (lbs.)	RATE (net cwt)
SCHEDULE N:	500	999	647	74.33
	1000	1999	1,626	48.03
	2000	3999	3,226	39.03
	4000	7999	7,202	31.47
	8000	and over		28.33

SCHEDULE O:	500	999	652	79.97
	1000	1999	1,620	52.09
	2000	3999	3,242	42.17
	4000	7999	7,206	34.18
	8000	and over		30.78

SCHEDULE P:	500	999	653	86.37
	1000	1999	1,609	56.39
	2000	3999	3,243	45.34
	4000	7999	7,210	36.76
	8000	and over		33.12

SCHEDULE Q:	500	999	655	92.38
	1000	1999	1,610	60.44
	2000	3999	3,254	48.65
	4000	7999	7,161	39.58
	8000	and over		35.42

SCHEDULE R: CANADA (ALL OTHERS)				
	500	999	653	53.49
	1000	1999	1,544	34.91
	2000	3999	3,406	26.93
	4000	7999	7,142	22.93
	8000	and over		20.47

SCHEDULE S: CANADA	500	999	653	57.87
	1000	1999	1,606	37.74
	2000	3999	2,950	30.30
	4000	7999	7,944	22.34
	8000	and over		22.18

	WEIGHT RANGE		BREAK POINT WT (lbs.)	RATE (net cwt)
SCHEDULE T: HAWAII:	500	999	629	50.98
	1000	1999	1,620	32.06
	2000	3999	3,296	25.96
	4000	7999	6,936	21.39
	8000	and over		18.54

SCHEDULE U: Japan				
	500	1999	1739	15.16
	2000	3999	3599	13.18
	4000	and over		11.86

SCHEDULE V: ALASKA: Any point within the State when point of pick-up or delivery and warehouse are both located within a distance of 50 miles or less.				
	500	999	674	72.98
	1000	1999	1,849	49.17
	2000	3999	3,840	45.45
	4000	7999	6,969	43.63
	8000	11999	10,575	38.01
	12000	and over		33.49

NOTE: When points are beyond 50 miles, add to 50-mile charge shown above, \$3.85 per mile per shipment for each mile over 50 miles.

SCHEDULE W: PUERTO RICO: Any point				
	500	and over		6.65

SCHEDULE X: GUAM: Any point				
	500	999	670	50.98
	1000	1999	1,544	32.06
	2000	3999	3,480	25.96
	4000	and over		21.39

SCHEDULE Y: Korea, Philippines, and other Pacific and Southern Command Areas (except Japan)				
	500	1999	1738	11.25
	2000	3999	3601	9.78
	4000	and over		8.80

	WEIGHT RANGE		BREAK POINT WT (lbs.)	RATE (net cwt)
SCHEDULE Z: Belgium, Italy, Netherlands, and Germany				
	500	1999	1739	22.99
	2000	3999	3597	19.99
	4000	and over		17.98

SCHEDULE AA: United Kingdom				
	500	1999	1738	14.74
	2000	3999	3599	12.81
	4000	and over		11.53

SCHEDULE BB: Greece, Spain, and other European Command Areas (except Belgium, Italy, Netherlands, Germany, and United Kingdom)				
	500	1999	1738	22.99
	2000	3999	3603	19.98
	4000	and over		17.99

SCHEDULE CC: Overseas areas for which rates are not otherwise provided				
	500	1999	1739	8.95
	2000	3999	3596	7.78
	4000	and over		7.00

Pickup or Delivery Transportation Rates applying on Storage-in-Transit	Apply Rates In Schedule
At any point within CONUS, refer to	State GBLOC Item 500 Table and Item 520A Schedules
All other points within Canada	R
CANADA: Provinces of British Columbia, Labrador and Territories of Northwest, Yukon and Toronto, Ontario; Ottawa, Ontario; Montreal, Quebec, Halifax, Nova Scotia; Ottawa, Ontario; Calgary, Alberta; Edmonton, Alberta; Edmonton, Alberta; Winnipeg, Manitoba; Hull, Quebec, and other points within a 25 miles radius of each city named	S
Hawaii	T
Japan	U
Alaska	V
Puerto Rico	W
Guam	X
Korea, Philippines, and other Pacific and Southern Command Areas	Y
Belgium, Italy, Netherlands, and Germany	Z
United Kingdom	AA
Greece, Spain, and other European Command Areas	BB
Overseas areas for which rates are not otherwise provided	CC

Item 521 - Pickup or Delivery Transportation Rates to Apply on SIT Shipments - UB

- (521A) - SIT Pickup/Delivery - CONUS - 30 mi or less - UB
- (521B) - SIT Pickup/Delivery - CONUS and the Island of Oahu - greater than 30 mi - UB
- (521C) - SIT Pickup/Delivery - Alaska - 30 mi or less - UB
- (521D) - SIT Pickup/Delivery - Alaska - greater than 30 mi - UB
- (521E) - SIT Pickup/Delivery - Germany - 30 mi or less - UB
- (521F) - SIT Pickup/Delivery - Germany - greater than 30 mi - UB
- (521G) - SIT Pickup/Delivery - Hawaii - 30 mi or less - UB
- (521H) - SIT Pickup/Delivery - Hawaii (except Oahu) - greater than 30 mi - UB
- (521I) - SIT Pickup/Delivery - OCONUS - 30 mi or less - UB
- (521J) - SIT Pickup/Delivery - OCONUS - greater than 30 mi - UB
- (521K) - SIT Delivery Minimum Charge - UB
- (521L) - SIT Delivery Admin Fee - UB

1. SIT Pickup and Delivery Transportation Rates on UB shipments will be handled under the same rules that apply to HHG with the following exceptions:

- a. Rates apply in territory or areas shown below based on location of warehouse where SIT service is provided. Charges are subject to a **\$70.47** (521K) minimum per shipment.
- b. The following rates apply within 30-mile radius of the original requested pickup address (Block 19 of the BL for origin SIT) or original requested delivery address (Block 18 of the BL for destination SIT) at the time the shipment is offered and accepted by the TSP, not the warehouse location:

2. Pickup/Delivery Rates within 30 Miles:

Applicable Rates When Warehouse Is Located At	Rates Per Gross cwt
Any point within CONUS (521A)	\$34.36
Overseas:	
Alaska (521C)	\$32.98
Germany (521E)	\$25.45
Hawaii (521G)	\$31.62
All other overseas areas (521I)	\$23.02

3. Pickup/Delivery Rates over 30 miles:

- a. Within CONUS and the Island of Oahu, Hawaii, apply the rates in the applicable Linehaul Rate Schedules or the above rates, whichever is greater, subject to **\$92.59** (521B) minimum charge per shipment.
 - b. Within Alaska, apply the rates in the applicable Linehaul Rate Schedules or the above rate, whichever is greater, subject to **\$92.59** (521D) minimum charge per shipment.
 - c. Germany (either origin and/or destination) apply rates in the applicable Linehaul Rate Schedules or the above rate, whichever is greater, subject to **\$49.96** (521F) minimum charge per shipment.
 - d. For shipments from/to Islands of Hawaii other than Oahu, the rate of **\$18.62** (521H) per gross cwt in addition to the above will apply.
 - e. Overseas (except Germany, Alaska, and Hawaii), apply the rates in the applicable Linehaul Rate Schedules or the above rate, whichever is greater, subject to **\$52.10** (521J) minimum charge per shipment.
 - f. An administrative fee of **\$29.49** (521L) per shipment.
4. Item 521 does not require pre-approval from the Government unless the following situations exist:
- a. Delivery out of SIT is greater than 100 miles
 - b. The customer has amended orders changing their assignment to a new gaining organization, unit/company, or installation that is outside of the original destination rate area/region and/or over 100 miles (using DTOD miles).
5. If a PPSO does not acknowledge a delivery address change request before the scheduled delivery date, the TSP shall deliver the shipment to meet the customer's expectation.

6. If the address is over 100 miles from block 18 of the BL, the TSP will not schedule delivery out of SIT until the approval has been entered in DPS.
7. The PPSO may order, subject to the TSP's concurrence, the services provided by this item during other than regular working hours.
8. The rates specified in this item plus overtime loading and/or unloading charges will apply.
 - a. These additional charges will not apply when service is performed for the convenience of the TSP.
 - b. When such service is ordered, it must be confirmed in writing.
 - c. Rates in effect on date of actual pickup at origin will apply.
9. Charges above are in addition to the SFR.

Item 522 - Termination of Shipments - HHG

(522A) - Termination Fee - HHG

(522B) - Termination Prior to Origin Departure - HHG

(522C) - Termination After Origin Departure - HHG

(522D) - Termination SFR Reduction - HHG/UB

1. A shipment will be terminated when appropriate and ordered by a PPSO or other authorized Government representative.
 - a. When an order for termination is received,
 - (1) the TSP will locate the shipment,
 - (2) advise the PPSO of shipment's location,
 - (3) effect the required change, and
 - (4) the PPSO will issue a BL correction notice to reflect the termination point.
2. The following will apply to shipments terminated for the convenience of the Government:
 - a. Shipments terminated prior to departure from the origin primary pickup address (both CONUS and OCONUS).
 - (1) Applicable payments are authorized as follows:
 - (a) In order to be paid for services rendered, the TSP is required to submit a legible inventory signed by the customer or designated representative to the Origin shipping office for approval and will be compensated by the cu ft for all HHG items
 - 1 packed,
 - 2 disassembled,
 - 3 prepared for movement,
 - 4 unpacked, and
 - 5 reassembled.

-
- (b) **\$39.18** (522B) per net cwt in CONUS
 - (c) **\$47.64** (522B) per net cwt in OCONUS
 - (2) The estimated weight of HHG, including PBP&E, will be determined by utilizing 7 lbs. per cu ft. The TSP must use the weight estimator located at <https://www.ustranscom.mil/dp3/weightestimator.cfm> to obtain the cubed weight for authorized HHG items.
- b. Shipments terminated after movement from origin but prior to commencement of ocean or air transportation. Applicable payments are authorized as follows:
- (1) Packing, including the use of packing materials and stuffing into HHG containers and unpacking.
 - (a) **\$34.98** (522C) per net cwt in CONUS
 - (b) **\$47.64** (522C) per net cwt in OCONUS
 - (c) Applicable linehaul rates to cover local drayage from residence to warehouse.
 - (d) Applicable linehaul rates from origin warehouse to point of termination.
 - (e) SIT and warehouse handling charges, when required and authorized.
 - (2) For shipments returning back to origin,
 - (a) TSP will be compensated
 - 1 using Item 530 Linehaul Rate Schedules from point of termination to origin warehouse,
 - 2 origin warehouse back to residence, and
 - 3 fuel surcharge (CONUS, AK, and HI only).
 - (3) Shipments placed in SIT in a DoD approved SIT facility waiting for further movement instructions from the PPSO,
 - (a) TSP will be authorized the following to complete delivery to the new destination
 - 1 delivery out of SIT,
 - 2 fuel surcharge (CONUS, AK, and HI only)
 - (b) To avoid the appearance of duplicate invoicing, invoicing for services will be submitted using Item Code 533A (MISC) with a note containing the Item Code the charge is for (i.e., Item Code 520, Item Code 513) and reason for using Item Code 533A (MISC). Exception: Termination fee will be submitted using Item Code 522A.
- c. Shipments terminated during or after the completion of over water transportation. Applicable payments are authorized as follows:
- (1) TSP's SFR to rate area of the termination point or TSP's SFR to the rate area of the original destination point, whichever is less,
 - (2) SFR reduced by **\$3.87** (522D) per cwt for non-performance of unpacking services. The BL correction notice will reflect this reduction.

- (3) If the shipment is to be delivered to a residence or warehouse also within the rate area of the termination point, the TSP's SFR rate as specified above plus appropriate charges for additional services as ordered by the PPSO on a DD Form 619, will apply.
3. A termination charge of **\$29.82** (522A) per shipment will apply in addition to other charges authorized herein. The termination charge will be supported by the BL correction notice.
4. When shipments are terminated through the fault of the TSP, the provisions of Chapter 3, Item 325, Shipment Termination, apply. The termination charge of **\$29.82** (522A) will not apply.
5. Any charges for services performed after the termination of the shipment will be in accordance with applicable rules and rates.

Item 523 - Termination of Shipments - UB

(523A) - Termination Fee - UB

(523B) - Termination Prior to Origin Departure - UB

(523C) - Termination After Origin Departure - UB

1. A shipment will be terminated when appropriate and ordered by a PPSO or other authorized Government representative.
 - a. When an order for termination is received,
 - (1) the TSP will locate the shipment,
 - (2) advise the PPSO of shipment's location,
 - (3) effect the required change, and
 - (4) the PPSO will issue a BL correction notice to reflect the termination point.
2. The following will apply to shipments terminated for the convenience of the Government:
 - a. Shipments terminated prior to departure from the origin primary pickup address (both CONUS and OCONUS).
 - (1) Applicable payments are authorized as follows:
 - (a) In order to be paid for services rendered, the TSP is required to submit a legible inventory signed by the customer or designated representative to the Origin shipping office for approval and will be compensated by the cu ft for all items
 - 1 packed,
 - 2 disassembled,
 - 3 prepared for movement,
 - 4 unpacked, and
 - 5 reassembled.
 - (b) **\$35.13** (523B) per gross cwt
 - (2) The estimated weight of UB, including PBP&E, will be determined by utilizing 7 lbs. per cu ft. The TSP must use the weight estimator located at

- <https://www.ustranscom.mil/dp3/weightestimator.cfm> to obtain the cubed weight for authorized items.
- b. Shipments terminated after movement from origin but prior to commencement of ocean or air transportation. Applicable payments are authorized as follows:
- (1) Packing, including the use of packing materials and stuffing into containers (if used) and unpacking.
 - (a) **\$30.92** (523C) per gross cwt
 - (b) Applicable linehaul rates to cover local drayage from residence to warehouse.
 - (c) Applicable linehaul rates from origin warehouse to point of termination.
 - (d) SIT and warehouse handling charges, when required and authorized.
 - (2) For shipments returning back to origin,
 - (a) TSP will be compensated
 - 1 using Item 530 Linehaul Rate Schedules from point of termination to origin warehouse,
 - 2 origin warehouse back to residence, and
 - 3 fuel surcharge (CONUS, AK, and HI only).
 - (3) Shipments placed in SIT in a DoD approved SIT facility waiting for further movement instructions from the PPSO,
 - (a) TSP will be authorized the following to complete delivery to the new destination
 - 1 delivery out of SIT,
 - 2 fuel surcharge (CONUS, AK, and HI only)
 - (b) To avoid the appearance of duplicate invoicing, invoicing for services will be submitted using Item Code 533A (MISC) with a note containing the Item Code the charge is for (i.e., Item Code 521, Item Code 513) and reason for using Item Code 533A (MISC). Exception: Termination fee will be submitted using Item Code 523A.
- c. Shipments terminated during or after the completion of ocean or air transportation. Applicable payments are authorized as follows:
- (1) TSP's SFR to rate area of the termination point or TSP's SFR to the rate area of the original destination point, whichever is less,
 - (2) SFR reduced by **\$3.87** (522D) per cwt for non-performance of unpacking services. The BL correction notice will reflect this reduction.
 - (3) If the shipment is to be delivered to a residence or warehouse also within the rate area of the termination point, the TSP's SFR rate as specified above plus appropriate charges for additional services as ordered by the PPSO on a DD Form 619, will apply.
3. A termination charge of **\$29.82** (523A) per shipment will apply in addition to other charges authorized herein. The termination charge will be supported by the BL correction notice.

4. When shipments are terminated through the fault of the TSP, the provisions of Chapter 3, Item 325, Shipment Termination, apply. The termination charge of **\$29.82** (523A) will not apply.
5. Any charges for services performed after the termination of the shipment will be in accordance with applicable rules and rates.
6. UB shipments requiring long delivery out of SIT in the USEUCOM area, due to customer's reassignment to another rate area location, will be terminated. The PPSO is responsible for determining and selecting the most cost-effective method for onward movement of the shipment.

Item 524 - Reshipments - HHG

(524A) - Reshipment Original TSP - HHG

(524B) - Reshipment New TSP - HHG

(524C) - Reshipment SFR Reduction - HHG/UB

1. Applies to HHG shipments terminated for the convenience of the Government and require air or ocean transportation.
2. The onward movement of property will be treated as a new shipment under a new BL.
3. A reshipment normally will be handled by the TSP originally tendered the shipment if that TSP has a cost effective USTRANSCOM approved rate on file or negotiates an acceptable OTO rate with USTRANSCOM.
4. The point of termination will be considered the final destination and the original BL will be terminated at that point.
5. The following procedures will be followed in determining applicable rates for the new BL:
 - a. If the TSP originally handling the shipment has a cost effective USTRANSCOM approved rate on file to the new destination, that SFR, reduced for the non-performance of packing and stuffing
 - (1) **\$17.53** (524A) per net cwt in CONUS, or
 - (2) **\$25.48** (524A) per net cwt in OCONUS, and
 - (3) The reduction will be supported by a PPSO annotation on the original BL.
 - b. If the TSP originally handling the shipment does not have a cost effective USTRANSCOM approved SFR on file to the new destination,
 - (1) an acceptable OTO SFR will be negotiated, or
 - (2) the shipment will be tendered to another TSP.
 - c. If the shipment is tendered to another TSP with a cost effective USTRANSCOM approved rate on file,
 - (1) SFR will be reduced by **\$6.45** (524B) per net cwt for non-performance of packing services

- (a) If a TSP must repack a shipment to ensure safe transport and/or for liability reasons, upon approval by the PPSO, the reduction for non-performance of packing will not apply.
 - (2) shipment will be de-containerized and re-stuffed into other containers and original containers returned to the owner.
 - d. If the onward transportation of the shipment is tendered to a TSP under a negotiated OTO rate, there is no reduction to the SFR.
 - e. For shipments that pickup from storage warehouses that are already packed, TSP may invoice an Inspection Fee of **\$3.87** per net cwt using Item Code 533A.
6. The above procedures are not applicable to those shipments terminated and retendered due to the fault of the TSP, such as TSP bankruptcy or failure to complete movement as defined in Chapter 3, Item 325. The following procedures will apply:
- a. Shipments will remain in the original TSP's containers. These containers will be made available to the original TSP by the new TSP at destination.
 - b. The SFR will be reduced by **\$6.45** (524C) per cwt for non-performance of packing services when the shipment is tendered to another TSP with a cost effective USTRANSCOM approved rate on file.
 - c. SFR reductions for non-performance of packing will not apply when OTO rates are solicited by USTRANSCOM to complete onward movement of these shipments.
7. Old and new BLs will be cross-referenced.

Item 525 - Reshipments - UB

(525A) - Reshipment Original TSP - UB

(525B) - Reshipment New TSP - UB

1. Applies to UB shipments terminated for the convenience of the Government and require air or ocean transportation.
2. The onward movement of property will be treated as a new shipment under a new BL.
3. A reshipment normally will be handled by the TSP originally tendered the shipment if that TSP has a cost effective USTRANSCOM approved rate on file or negotiates an acceptable OTO rate with USTRANSCOM.
4. The point of termination will be considered the final destination and the original BL will be terminated at that point.
5. The following procedures will be followed in determining applicable rates for the new BL:
 - a. If the TSP originally handling the shipment has a cost effective USTRANSCOM approved rate on file to the new destination, that SFR, reduced for the non-performance of packing
 - (1) **\$6.45** (525A) per gross cwt
 - (2) The reduction will be supported by a PPSO annotation on the original BL.

- b. If the TSP originally handling the shipment does not have a cost effective USTRANSCOM approved SFR on file to the new destination,
 - (1) an acceptable OTO SFR will be negotiated, or
 - (2) the shipment will be tendered to another TSP.
 - c. If the shipment is tendered to another TSP with a cost effective USTRANSCOM approved rate on file,
 - (1) SFR will be reduced by **\$6.45** (525B) per gross cwt for non-performance of packing services.
 - (a) If a TSP must repack a shipment to ensure safe transport and/or for liability reasons, upon approval by the PPSO, the reduction for non-performance of packing will not apply.
 - d. If the onward transportation of the shipment is tendered to a TSP under a negotiated OTO rate, there is no reduction to the SFR.
6. Old and new BLs will be cross-referenced.

Item 526 - Shipments Diverted After Commencement of Transportation Service

(526A) - Diversion Charge

(526B) - Diversion: Port Handling

(526C) - Diversion: Storage Charge

1. Linehaul transportation charges in connection with a diversion shall be billed under Item Code 533A Miscellaneous Charge.
2. Upon instructions made and confirmed in writing by the PPSO, shipments will be diverted subject to the provisions and charges shown below.
3. Diversion of some shipments affect the SFR. Bill the adjustment caused by a diversion using the appropriate item code(s) as prescribed below.
4. When charges are assessed in accordance with the provisions of this item, the charges associated with delivery from SIT herein will not apply.
5. Diversion requests for OTO shipments must be submitted by the PPSO to USTRANSCOM PP Special Requirements & Rates Team transcom.scott.tcj9.mbx.pp-rates-oto@mail.mil for further shipment instructions.
6. All diversion requests must include notations in the Additional Remarks section of the DPS shipment record.
7. A diversion will be made only
 - a. at an ocean or aerial port of embarkation,
 - b. an ocean or aerial port of debarkation, or
 - c. at destination point.
 - d. EXCEPTION: The provisions of this item will not apply if instructions are received to change the destination of a shipment that is in SIT at destination. In such instances,

transportation charges to the new destination point from the SIT warehouse will be computed under the provisions of Pickup/Delivery Transportation Rate to apply on SIT shipments.

8. The term(s) diverted or diversion as used herein means a change to the destination point more than 50 miles from the original destination point.
 - a. If the PPSO directs the movement of the shipment to a place which is less than 50 miles (see Item 520 and Item 521) from the original destination point of the shipment, the shipment will be terminated at the point designated by the PPSO and no diversion will occur. In such instance, the SFR will be that applicable to the original destination point.
 - b. If the PPSO directs the movement of the shipment to a place which is more than 50 miles from the original destination point, the transportation charges as stated below apply.
 - c. A charge per shipment (526A) applies when a change to a new destination point occurs more than 50 miles from the original destination point.
9. Shipments diverted at an overseas terminal to another overseas destination point.
 - a. Additional port handling charge(s) may apply. Bill the additional port handling charge(s) as Item Code 526B for actual costs incurred supported by a copy of the original invoice(s) from port agent.
 - b. Storage charges may apply to some shipments. Bill the storage charge as Item Code 526C for actual costs incurred supported by a copy of the original invoice(s) from port agent.
10. When an order for diversion is received by TSP:
 - a. Diligent effort will be made by the TSP to locate the shipment at the ocean or aerial port of embarkation or debarkation, or destination and effect the change desired.
 - b. TSP will not be responsible for failure to effect the change ordered unless such failure is due to error or negligence of the TSP or its employees.
11. Upon receipt of an order to divert from the PPSO, the TSP may bill (with PPSO approval) a diversion charge of **\$59.64** (526A) per shipment.
12. Refer to the DTR Part IV, Chapter 402, Paragraph E.4 (Diversion Scenarios) for guidance on how to process diversions. If assistance is needed with shipments that require a diversion contact USTRANSCOM PP Operational & Quality Support Team via e-mail at transcom.scott.tcj9.mbx.pp-ops@mail.mil.
13. If the TSP does not have a SFR on file from the origin to the new destination, the shipment will be terminated and the nearest PPSO will direct the shipment as required.

Item 527 - Delivery of Split Code T Shipments

(527A) - Code T Multi Port Pickups

(527B) - Code T Multi Port Deliveries

1. Door-to-Door Container AMC (Code T) shipments which arrive at the POD on separate aircraft and are offered to the TSP or TSP's agent not consolidated, may be considered split shipments.

- a. When offered a split shipment by an aerial POD, the TSP or TSP's agent will obtain a certificate from the aerial port that a complete shipment could not be provided.
 - (1) The certificate must provide the flight number which will be applicable to each portion of the split shipment.
 - (2) When pickups of a split shipment results in more than one pickup at the port/terminal, compensation to TSP for extra pickups at the port will be **\$32.25** (527A).
 - (3) When receipt of a split shipment results in more than one delivery to residence to completely deliver shipment, the following additional charge will apply:
 - (a) CONUS destination: each delivery in addition to the first delivery will be **\$51.60** (527B).
 - (b) OCONUS destination: each delivery in addition to the first delivery will be **\$21.24** (527B).
2. Charges for delivery of split Code T shipments will be supported by
 - a. copies of the POD certificates for each increment and
 - b. a separate DD Form 619, issued by the destination PPSO stating the number of multiple deliveries ordered by the PPSO and performed by the International TSP to complete shipment.
3. When a split delivery occurs between two ports, both the provisions of Items 527 and 528 should be made applicable.
 - a. Only that portion of the shipment arriving at the non-designated POD would append the linehaul adjustment of Item 528.
 - b. Both PODs should issue the certificate of split/partial delivery.
 - c. The POD receiving the portion as a non-designated POD should issue the separate certificate supporting Item 528.

Item 528 - Use of Alternate Ports for Code T Shipments

(528A) - Alternate Port - HHG

1. When a Code T shipment (also applicable when Code 4 shipments are off-loaded at other than manifested POD) is routed through a military ocean/aerial terminal (MOT/MAT) other than the designated MOT/MAT and this results in different land mileage, adjustments of such mileage differential will be computed as follows:
 - a. If the mileage between the MOT/MAT used and the origin or destination point exceeds the distance between the designated MOT/MAT and the origin or destination point, the TSP is entitled to
 - (1) be paid for such excess mileage based upon the applicable Linehaul Rate Schedule and
 - (2) the applicable SFR.
 - b. If the mileage between the MOT/MAT used and the origin or destination point is less than the distance between the designated MOT/MAT and the origin or destination point,

-
- (1) TSP should reduce the applicable SFR by the mileage differential based upon 100 percent of the applicable Linehaul Rate Schedule,
 - (2) invoice utilizing Item Code 528A and referencing LHS,
 - (3) alternate port/terminal must be identified when an adjustment to the SFR is caused by use of alternate port/terminal, and
 - (4) identify the alternate port/terminal next to the charge when billing.
 - (a) Use the authorized port/terminal codes identified in this Tender.
 - (b) Use the N1 segment as defined by the DoD EDI Convention to identify the alternate port/terminal when billing via EDI.
2. TSPs will deliver COS T shipments to the MOT/MAT shown on the Transportation Control Movement Document (TCMD).
 3. When the designated terminal/port is changed during a rate cycle,
 - a. the origin PPSO will certify the use of alternate port/terminal.
 - (1) Certification will contain
 - (a) the original port/terminal,
 - (b) revised port/terminal, and
 - (c) increase/decrease in mileage.
 - b. If the shipment is directed to a port/terminal other than that shown on the TCMD,
 - (1) a government representative at the port/terminal will provide the TSP a certificate showing the port/terminal used, and
 - (2) indicate where the shipment was received from or returned to the custody of the TSP.
 - c. These certificates must accompany the original BL and other documentation to support billing.
 4. All documentation must be kept for the purposes of any post audit. To substantiate the ports/terminals utilized, the TSP will submit with their billing, any one of the following documents designating such ports/terminals:
 - a. Thru BL
 - b. Ocean freight bill
 - c. Port agent invoice
 - d. Underlying linehaul TSP bill of lading
 - e. Certificate issued by a PPSO or terminal officer showing the port/terminal used
 5. When for any reason, (i.e., strikes or other emergencies), International Code 4 shipments are ordered off-loaded at a MOT instead of the manifested commercial POD, and this results in a differential in land mileage, adjustment will be computed in accordance with above.

Item 529 – Use of Alternate Ports for Code J Shipments

(529A) - Alternate Port - UB

1. When a Code J shipment is routed through a military aerial terminal (MAT) other than the designated MAT and this results in different land mileage, adjustments or such mileage differential will be computed as follows:
 - a. If the mileage between the MAT used and the origin or destination point exceeds the distance between the designated MAT and the origin or destination point, the TSP is entitled to
 - (1) be paid for such excess mileage based upon the applicable Linehaul Rate Schedule and
 - (2) the applicable SFR.
 - b. If the mileage between the MAT used and the origin or destination point is less than the distance between the designated MAT and the origin or destination point,
 - (1) TSP should reduce the applicable SFR by the mileage differential based upon 100 percent of the applicable Linehaul Rate Schedule,
 - (2) invoice utilizing Item Code 529A and referencing LHS,
 - (3) alternate terminal must be identified when an adjustment to the SFR is caused by the use of an alternate terminal,
 - (4) identify the alternate terminal next to the charge when billing.
 - (a) Use the authorized terminal codes identified in this Tender.
2. TSPs will deliver Code J shipments to the MAT shown on the Transportation Control Movement Document (TCMD).
3. Mileage calculations from the alternate APOE will be based on where the shipment is physically located (e.g., if the physical shipment location is the original APOE MAT that location is utilized as the start point for mileage calculations; if the physical shipment location is at the agent warehouse, then that location would be the start point for mileage calculations).
4. TSP will only be compensated for services rendered; mileage not serviced to the original APOE will be subtracted from the alternate APOE mileage calculation.
5. The destination point for Code J shipments due to a MAT closure is to be considered as the port agent's facility. The difference between the original APOD MAT and the alternate APOD MAT should be used for the purposes of calculating any mileage differences due to use of an alternate MAT.
 - a. The final destination of the shipment will have no bearing on the calculation of excess mileage. The TSP must receive a copy of the TCMD (provided by AMC) from the port agent for billing, showing the alternate APOD used.
6. When the designated terminal is changed during a rate cycle,
 - a. the origin PPSO will certify the use of alternate terminals.
 - (1) Certification will contain

- (a) the original terminal,
 - (b) revised terminal, and
 - (c) increase/decrease in mileage.
 - b. If the shipment is directed to a terminal other than that shown on the TCMD,
 - (1) a government representative at the terminal will provide the TSP a certificate showing the terminal used, and
 - (2) indicate where the shipment was received from or returned to the custody of the TSP.
 - c. These certificates must accompany the original BL and other documentation to support billing.
7. All documentation must be kept for the purposes of any post audit. To substantiate the terminals utilized, the TSP will submit, with their billing, any one of the following documents designating such terminals:
- a. Thru BL
 - b. Ocean freight bill
 - c. Port agent invoice
 - d. Underlying linehaul TSP bill of lading
 - e. Certificate issued by a PPSO or terminal officer showing the aerial port used.

Item 530 - Linehaul Rate Schedules

Use the following Linehaul Rate Schedules for delivery in/out of SIT, diversions, terminations, alternate ports, etc.

Schedule A: Household Goods												
CONUS Linehaul Rates Including Alaska and Hawaii												
LOW MILE	HIGH MILE	500 to 999	Break Point	1000 to 1999	Break Point	2000 to 3999	Break Point	4000 to 7999	Break Point	8000 to 11999	Break Point	12000 & OVER
1	10	16.90	652	11.01	1,682	9.26	3,485	8.06	6,470	6.52	11,613	6.31
11	20	17.53	668	11.71	1,641	9.61	3,387	8.13	6,621	6.73	11,500	6.45
21	30	18.37	672	12.34	1,637	10.10	3,389	8.55	6,361	6.80	11,506	6.52
31	40	19.42	650	12.62	1,634	10.31	3,375	8.69	6,581	7.15	11,412	6.80
41	50	20.33	649	13.18	1,660	10.94	3,385	9.26	6,243	7.22	11,534	6.94
51	60	21.25	637	13.53	1,648	11.15	3,372	9.40	6,687	7.85	11,036	7.22
61	70	22.09	642	14.16	1,654	11.71	3,282	9.61	6,774	8.13	11,587	7.85
71	80	22.93	646	14.80	1,621	11.99	3,346	10.03	6,826	8.55	11,410	8.13
81	90	23.98	638	15.29	1,624	12.41	3,323	10.31	6,749	8.69	11,807	8.55
91	100	24.89	629	15.64	1,624	12.69	3,426	10.87	6,865	9.33	11,188	8.69
101	110	25.87	632	16.34	1,614	13.18	3,320	10.94	6,872	9.40	11,195	8.77
111	120	26.65	635	16.90	1,594	13.46	3,271	11.01	6,930	9.54	11,736	9.33
121	130	27.42	637	17.46	1,575	13.74	3,245	11.15	6,894	9.61	11,738	9.40
131	140	28.05	640	17.95	1,579	14.16	3,268	11.57	6,885	9.96	11,493	9.54
141	150	28.89	636	18.37	1,588	14.59	3,193	11.64	6,892	10.03	11,917	9.96
151	160	29.45	643	18.93	1,571	14.87	3,208	11.92	6,824	10.17	11,918	10.10
161	170	30.22	648	19.56	1,535	15.01	3,290	12.34	7,046	10.87	11,226	10.17
171	180	30.92	647	19.98	1,544	15.43	3,255	12.55	7,017	11.01	11,236	10.31
181	190	31.55	645	20.33	1,559	15.85	3,204	12.69	7,293	11.57	11,200	10.80
191	200	32.33	640	20.69	1,573	16.27	3,242	13.18	7,107	11.71	11,282	11.01
201	220	33.17	641	21.25	1,578	16.76	3,231	13.53	7,296	12.34	11,250	11.57
221	240	34.08	640	21.81	1,602	17.46	3,213	14.02	7,201	12.62	11,334	11.92
241	260	34.85	650	22.65	1,579	17.88	3,169	14.16	7,248	12.83	11,738	12.55
261	280	35.76	642	22.93	1,615	18.51	3,213	14.87	7,284	13.53	11,379	12.83
281	300	36.46	645	23.49	1,636	19.21	3,183	15.29	7,377	14.09	11,523	13.53
301	320	37.44	647	24.19	1,629	19.70	3,175	15.64	7,462	14.59	11,597	14.09
321	340	38.15	653	24.89	1,634	20.33	3,214	16.34	7,348	15.01	11,664	14.59

**Schedule A: Household Goods
CONUS Linehaul Rates Including Alaska and Hawaii**

LOW MILE	HIGH MILE	500 to 999	Break Point	1000 to 1999	Break Point	2000 to 3999	Break Point	4000 to 7999	Break Point	8000 to 11999	Break Point	12000 & OVER
341	360	38.85	665	25.80	1,636	21.11	3,203	16.90	7,370	15.57	11,568	15.01
361	380	39.62	666	26.37	1,655	21.81	3,216	17.53	7,424	16.27	11,483	15.57
381	400	40.39	662	26.72	1,675	22.37	3,211	17.95	7,532	16.90	11,552	16.27
401	420	41.02	671	27.49	1,659	22.79	3,250	18.51	7,576	17.53	11,472	16.76
421	440	41.86	667	27.91	1,669	23.28	3,266	19.00	7,558	17.95	11,672	17.46
441	460	42.77	661	28.26	1,698	23.98	3,264	19.56	7,570	18.51	11,455	17.67
461	480	43.62	666	29.03	1,677	24.33	3,286	19.98	7,579	18.93	11,378	17.95
481	500	44.39	664	29.45	1,691	24.89	3,268	20.33	7,559	19.21	11,563	18.51
501	520	45.09	671	30.22	1,694	25.59	3,233	20.69	7,567	19.56	11,613	18.93
521	540	45.72	668	30.50	1,706	26.01	3,267	21.25	7,525	19.98	11,537	19.21
541	560	46.21	670	30.92	1,715	26.51	3,249	21.53	7,558	20.33	11,545	19.56
561	580	46.91	670	31.41	1,701	26.72	3,287	21.95	7,540	20.69	11,431	19.70
581	600	47.26	671	31.69	1,726	27.35	3,242	22.16	7,621	21.11	11,562	20.33
601	620	47.89	674	32.26	1,705	27.49	3,296	22.65	7,530	21.32	11,645	20.69
621	640	48.45	672	32.54	1,707	27.77	3,283	22.79	7,705	21.95	11,464	20.97
641	660	48.87	673	32.89	1,706	28.05	3,320	23.28	7,615	22.16	11,507	21.25
661	680	49.29	670	33.03	1,750	28.89	3,263	23.56	7,691	22.65	11,406	21.53
681	700	49.86	670	33.38	1,748	29.17	3,289	23.98	7,603	22.79	11,631	22.09
701	725	50.28	673	33.80	1,743	29.45	3,286	24.19	7,629	23.07	11,636	22.37
726	750	50.70	681	34.50	1,724	29.73	3,284	24.40	7,725	23.56	11,572	22.72
751	775	51.26	680	34.85	1,735	30.22	3,277	24.75	7,751	23.98	11,474	22.93
776	800	51.61	684	35.27	1,730	30.50	3,357	25.59	7,606	24.33	11,586	23.49
801	825	52.17	686	35.76	1,730	30.92	3,366	26.01	7,612	24.75	11,661	24.05
826	850	52.31	690	36.04	1,744	31.41	3,349	26.30	7,659	25.17	11,633	24.40
851	875	52.52	689	36.18	1,745	31.55	3,361	26.51	7,789	25.80	11,511	24.75
876	900	53.01	688	36.46	1,747	31.83	3,357	26.72	7,812	26.08	11,484	24.96
901	925	53.22	694	36.88	1,750	32.26	3,400	27.42	7,694	26.37	11,649	25.59
926	950	53.71	695	37.30	1,745	32.54	3,414	27.77	7,677	26.65	11,716	26.01
951	975	53.85	698	37.58	1,754	32.96	3,430	28.26	7,742	27.35	11,570	26.37
976	1,000	55.26	683	37.72	1,770	33.38	3,471	28.96	7,632	27.63	11,605	26.72
1,001	1,050	56.52	687	38.78	1,769	34.29	3,444	29.52	7,829	28.89	11,593	27.91
1,051	1,100	58.27	683	39.76	1,775	35.27	3,484	30.71	7,690	29.52	11,744	28.89
1,101	1,150	59.67	681	40.60	1,783	36.18	3,481	31.48	7,751	30.50	11,614	29.52
1,151	1,200	61.15	685	41.86	1,783	37.30	3,459	32.26	7,809	31.48	11,626	30.50

Schedule A: Household Goods
CONUS Linehaul Rates Including Alaska and Hawaii

LOW MILE	HIGH MILE	500 to 999	Break Point	1000 to 1999	Break Point	2000 to 3999	Break Point	4000 to 7999	Break Point	8000 to 11999	Break Point	12000 & OVER
1,201	1,250	62.48	684	42.70	1,774	37.87	3,489	33.03	7,814	32.26	11,714	31.48
1,251	1,300	63.81	684	43.62	1,779	38.78	3,487	33.80	7,818	33.03	11,720	32.26
1,301	1,350	64.72	687	44.46	1,786	39.69	3,513	34.85	7,759	33.80	11,702	32.96
1,351	1,400	65.56	695	45.51	1,776	40.39	3,514	35.48	7,795	34.57	11,684	33.66
1,401	1,450	66.54	697	46.35	1,777	41.16	3,510	36.11	7,861	35.48	11,692	34.57
1,451	1,500	67.46	699	47.12	1,780	41.93	3,519	36.88	7,848	36.18	11,698	35.27
1,501	1,550	68.16	703	47.89	1,787	42.77	3,528	37.72	7,837	36.95	11,750	36.18
1,551	1,600	69.00	705	48.59	1,796	43.62	3,531	38.50	7,826	37.65	11,777	36.95
1,601	1,650	69.70	707	49.22	1,801	44.32	3,545	39.27	7,815	38.36	11,781	37.65
1,651	1,700	70.54	707	49.86	1,809	45.09	3,553	40.04	7,818	39.13	11,764	38.36
1,701	1,750	71.38	708	50.49	1,812	45.72	3,553	40.60	7,835	39.76	11,810	39.13
1,751	1,800	72.01	712	51.26	1,820	46.63	3,561	41.51	7,811	40.53	11,772	39.76
1,801	1,850	72.86	717	52.17	1,804	47.05	3,577	42.07	7,840	41.23	11,796	40.53
1,851	1,900	73.42	721	52.87	1,794	47.40	3,616	42.84	7,830	41.93	11,800	41.23
1,901	1,950	74.33	723	53.71	1,802	48.38	3,595	43.47	7,859	42.70	11,764	41.86
1,951	2,000	74.96	725	54.34	1,799	48.87	3,605	44.04	7,848	43.19	11,864	42.70
2,001	2,050	75.94	728	55.26	1,795	49.58	3,616	44.81	7,850	43.97	11,867	43.47
2,051	2,100	76.57	728	55.68	1,807	50.28	3,627	45.58	7,804	44.46	11,887	44.04
2,101	2,150	77.34	731	56.52	1,804	50.98	3,637	46.35	7,807	45.23	11,833	44.60
2,151	2,200	78.04	730	56.94	1,813	51.61	3,647	47.05	7,786	45.79	11,853	45.23
2,201	2,250	78.61	734	57.64	1,816	52.31	3,636	47.54	7,847	46.63	11,784	45.79
2,251	2,300	79.24	738	58.41	1,816	53.01	3,646	48.31	7,803	47.12	11,804	46.35
2,301	2,350	79.80	737	58.76	1,824	53.57	3,634	48.66	7,816	47.54	11,877	47.05
2,351	2,400	80.43	741	59.53	1,810	53.85	3,662	49.29	7,853	48.38	11,792	47.54
2,401	2,450	81.20	741	60.09	1,809	54.34	3,681	50.00	7,787	48.66	11,931	48.38
2,451	2,500	81.69	744	60.72	1,816	55.11	3,665	50.49	7,812	49.29	11,898	48.87
2,501	2,550	81.97	746	61.15	1,812	55.40	3,661	50.70	7,890	50.00	11,832	49.29
2,551	2,600	82.18	747	61.36	1,822	55.89	3,669	51.26	7,880	50.49	11,867	49.93
2,601	2,650	82.88	746	61.78	1,830	56.52	3,653	51.61	7,881	50.84	11,835	50.14
2,651	2,700	83.09	751	62.34	1,825	56.87	3,675	52.24	7,882	51.47	11,772	50.49
2,701	2,750	83.37	751	62.55	1,826	57.08	3,671	52.38	7,904	51.75	11,789	50.84
2,751	2,800	83.58	755	63.04	1,829	57.64	3,679	53.01	7,895	52.31	11,807	51.47
2,801	2,850	84.28	753	63.39	1,828	57.92	3,700	53.57	7,896	52.87	11,746	51.75
2,851	2,900	84.50	757	63.95	1,827	58.41	3,688	53.85	7,896	53.15	11,811	52.31

**Schedule A: Household Goods
CONUS Linehaul Rates Including Alaska and Hawaii**

LOW MILE	HIGH MILE	500 to 999	Break Point	1000 to 1999	Break Point	2000 to 3999	Break Point	4000 to 7999	Break Point	8000 to 11999	Break Point	12000 & OVER
2,901	2,950	84.78	756	64.09	1,832	58.69	3,704	54.34	7,887	53.57	11,843	52.87
2,951	3,000	85.20	760	64.72	1,827	59.11	3,697	54.62	7,888	53.85	11,860	53.22
3,001	3,050	85.76	761	65.21	1,831	59.67	3,704	55.26	7,869	54.34	11,877	53.78
3,051	3,100	86.04	761	65.42	1,835	60.02	3,692	55.40	7,950	55.04	11,756	53.92
3,101	3,150	86.18	762	65.63	1,842	60.44	3,699	55.89	7,910	55.26	11,818	54.41
3,151	3,200	86.74	764	66.26	1,840	60.93	3,715	56.59	7,852	55.54	11,894	55.04
3,201	3,250	86.88	766	66.54	1,838	61.15	3,721	56.87	7,882	56.03	11,835	55.26
3,251	3,300	87.37	769	67.11	1,842	61.78	3,696	57.08	7,932	56.59	11,748	55.40
3,301	3,350	87.44	770	67.25	1,846	62.06	3,711	57.57	7,893	56.80	11,763	55.68
3,351	3,400	87.79	767	67.32	1,855	62.41	3,713	57.92	7,884	57.08	11,853	56.38
3,401	3,450	88.14	766	67.46	1,855	62.55	3,736	58.41	7,885	57.57	11,796	56.59
3,451	3,500	88.21	770	67.88	1,846	62.62	3,736	58.48	7,885	57.64	11,840	56.87
3,501	3,550	88.42	770	68.02	1,858	63.18	3,716	58.69	7,895	57.92	11,826	57.08
3,551	3,600	88.63	773	68.44	1,853	63.39	3,731	59.11	7,906	58.41	11,828	57.57
3,601	3,650	88.98	773	68.72	1,858	63.81	3,719	59.32	7,906	58.62	11,814	57.71
3,651	3,700	89.26	773	69.00	1,856	64.02	3,729	59.67	7,878	58.76	11,900	58.27
3,701	3,750	89.82	773	69.35	1,851	64.16	3,743	60.02	7,888	59.18	11,858	58.48
3,751	3,800	89.96	774	69.63	1,860	64.72	3,727	60.30	7,898	59.53	11,831	58.69

Schedule B-1: Household Goods Japan						
LOW MILE	HIGH MILE	500 to 1999	Break Point	2000 to 3999	Break Point	4000 & OVER
1	50	6.09	1,739	5.30	3,560	4.71
51	75	7.10	1,740	6.18	3,574	5.52
76	100	8.12	1,739	7.06	3,579	6.32
101	150	9.14	1,740	7.95	3,600	7.16
151	200	10.16	1,739	8.83	3,601	7.95
201	250	11.17	1,740	9.71	3,603	8.75
251	300	12.19	1,739	10.60	3,592	9.51
301	350	13.20	1,740	11.48	3,601	10.33
351	400	14.23	1,738	12.36	3,598	11.12
401	450	15.22	1,740	13.24	3,603	11.92
451	500	16.24	1,739	14.12	3,601	12.71
501	550	17.26	1,739	15.00	3,604	13.52
551	600	18.27	1,740	15.89	3,600	14.30
601	650	19.29	1,740	16.77	3,603	15.11
651	700	20.31	1,739	17.66	3,601	15.89
701	750	21.32	1,740	18.54	3,602	16.69
751	800	22.34	1,739	19.42	3,600	17.48
801	850	23.36	1,740	20.31	3,599	18.27
851	900	24.37	1,740	21.19	3,600	19.07
Over 900 miles, add \$1.66 for each additional 100 miles or fraction thereof to 900-mile rate shown						

Schedule B-2: Household Goods Korea, Philippines, and other Pacific and Southern Command Areas (except Japan)						
LOW MILE	HIGH MILE	500 to 1999	Break Point	2000 to 3999	Break Point	4000 & OVER
1	50	6.07	1,736	5.27	3,605	4.75
51	75	7.08	1,735	6.14	3,609	5.54
76	100	8.20	1,738	7.12	3,603	6.41
101	150	10.55	1,739	9.17	3,594	8.24
151	200	11.70	1,736	10.15	3,613	9.17
201	250	12.88	1,740	11.20	3,602	10.09
251	300	14.05	1,739	12.21	3,601	10.99
301	350	15.23	1,739	13.23	3,600	11.91
351	400	16.38	1,741	14.26	3,599	12.83
Over 400 miles, add \$1.55 for each additional 100 miles or fraction thereof to 400-mile rate shown						

Schedule B-3: Household Goods Belgium, Italy, Netherlands, and Germany						
LOW MILE	HIGH MILE	500 to 1999	Break Point	2000 to 3999	Break Point	4000 & OVER
1	50	6.56	1,738	5.70	3,617	5.15
51	75	7.64	1,742	6.65	3,609	6.00
76	100	8.73	1,740	7.59	3,608	6.85
101	150	10.15	1,739	8.82	3,600	7.94
151	200	11.84	1,736	10.27	3,602	9.25
201	250	13.02	1,741	11.33	3,595	10.18
251	300	14.20	1,741	12.35	3,596	11.11
301	350	15.38	1,740	13.38	3,600	12.04
351	400	16.56	1,740	14.40	3,597	12.95
401	450	17.74	1,740	15.43	3,601	13.89
451	500	18.94	1,741	16.48	3,599	14.83
501	550	20.10	1,739	17.48	3,605	15.75
551	600	21.29	1,738	18.50	3,602	16.66
601	650	22.49	1,738	19.53	3,603	17.59
651	700	23.65	1,741	20.58	3,596	18.50
701	750	24.84	1,740	21.60	3,599	19.43
751	800	26.02	1,740	22.63	3,599	20.36
801	850	27.21	1,739	23.65	3,601	21.29
851	900	28.37	1,741	24.68	3,600	22.21
901	950	29.57	1,739	25.71	3,563	22.89
951	1000	30.75	1,739	26.73	3,604	24.08
1001	1100	31.91	1,740	27.76	3,602	25.00
1101	1200	35.50	1,739	30.85	3,600	27.76
1201	1300	37.83	1,740	32.90	3,600	29.61
1301	1400	40.21	1,740	34.97	3,599	31.46
1401	1500	42.59	1,739	37.01	3,604	33.34
1501	1600	44.93	1,740	39.08	3,601	35.18
Over 1,600 miles, add \$1.67 for each additional 100 miles or fraction thereof to the 600-mile rate shown						

Schedule B-4: Household Goods Greece, Spain, and other European Command Areas (except Belgium, Italy, Netherlands, United Kingdom, and Germany)						
LOW MILE	HIGH MILE	500 to 1999	Break Point	2000 to 3999	Break Point	4000 & OVER
1	50	8.19	1,749	7.16	3,590	6.43
51	75	11.53	1,737	10.01	3,608	9.03
76	100	13.15	1,736	11.41	3,613	10.30
101	150	14.77	1,741	12.86	3,611	11.60
151	200	16.46	1,735	14.28	3,602	12.86
201	250	18.06	1,740	15.70	3,600	14.13
251	300	19.72	1,739	17.15	3,600	15.43
301	350	21.34	1,741	18.57	3,604	16.73
351	400	23.01	1,736	19.97	3,602	17.98
401	450	24.66	1,740	21.44	3,598	19.28
451	500	26.30	1,739	22.86	3,597	20.56
501	550	27.92	1,739	24.26	3,604	21.86
551	600	29.59	1,738	25.71	3,596	23.11
601	650	31.21	1,741	27.16	3,603	24.46
651	700	32.83	1,740	28.56	3,602	25.71
701	750	34.49	1,740	30.00	3,601	27.01
751	800	36.14	1,740	31.43	3,601	28.29
801	850	37.78	1,738	32.83	3,606	29.59
851	900	39.42	1,739	34.27	3,600	30.84
Over 900 miles, add \$1.18 for each additional 100 miles or fraction thereof to the 900-mile rate shown						

Schedule B-5: Household Goods United Kingdom						
LOW MILE	HIGH MILE	500 to 1999	Break Point	2000 to 3999	Break Point	4000 & OVER
1	50	5.12	1,731	4.43	3,604	3.99
51	75	7.05	1,731	6.10	3,606	5.50
76	100	8.03	1,736	6.97	3,599	6.27
101	150	9.04	1,728	7.80	3,599	7.02
151	200	10.03	1,741	8.73	3,603	7.86
201	250	11.04	1,739	9.60	3,598	8.63
251	300	12.04	1,740	10.48	3,600	9.43
301	350	13.05	1,739	11.34	3,586	10.17
351	400	14.06	1,740	12.22	3,598	10.99
401	450	15.05	1,738	13.08	3,586	11.72
451	500	16.06	1,739	13.96	3,604	12.57
501	550	17.06	1,740	14.84	3,601	13.36
551	600	18.06	1,740	15.71	3,602	14.14
601	650	19.05	1,741	16.57	3,599	14.91
651	700	20.07	1,740	17.46	3,600	15.71
701	750	21.06	1,739	18.31	3,600	16.48
751	800	22.09	1,738	19.19	3,604	17.29
801	850	23.06	1,741	20.07	3,602	18.07
851	900	24.07	1,740	20.94	3,600	18.84
Over 900 miles, add \$1.25 for each additional 100 miles or fraction thereof to the 900-mile rate shown						

Schedule B-6: Household Goods						
Overseas Areas for which rates are not otherwise provided						
LOW MILE	HIGH MILE	500 to 1999	Break Point	2000 to 3999	Break Point	4000 & OVER
1	50	3.13	1,730	2.70	3,583	2.42
51	75	4.24	1,727	3.66	3,614	3.30
76	100	4.83	1,734	4.18	3,591	3.76
101	150	5.43	1,727	4.69	3,603	4.22
151	200	6.01	1,745	5.24	3,597	4.71
201	250	6.63	1,742	5.77	3,590	5.18
251	300	7.24	1,739	6.29	3,600	5.66
301	350	7.84	1,740	6.82	3,586	6.11
351	400	8.45	1,738	7.34	3,574	6.55
401	450	9.05	1,736	7.85	3,583	7.03
451	500	9.64	1,742	8.39	3,598	7.55
501	550	10.25	1,740	8.91	3,599	8.02
551	600	10.84	1,742	9.44	3,600	8.50
601	650	11.45	1,738	9.95	3,600	8.95
651	700	12.06	1,739	10.49	3,601	9.44
701	750	12.66	1,740	11.00	3,597	9.89
751	800	13.26	1,738	11.52	3,607	10.39
801	850	13.85	1,742	12.06	3,599	10.85
851	900	14.46	1,739	12.57	3,603	11.32
Over 900 miles, add \$.83 for each additional 100 miles or fraction thereof to the 900-mile rate shown						

Schedule C: Unaccompanied Baggage						
Applies to Points within CONUS and Hawaii						
LOW MILE	HIGH MILE	350 to 999	Break Point	1000 to 1999	Break Point	2000 & OVER
1	10	14.09	657	9.26	1,637	7.57
11	20	14.87	647	9.61	1,679	8.06
21	30	15.57	654	10.17	1,683	8.55
31	40	16.69	648	10.80	1,637	8.84
41	50	17.39	642	11.15	1,673	9.33
51	60	18.09	644	11.64	1,639	9.54
61	70	18.79	642	12.06	1,663	10.03
71	80	19.56	642	12.55	1,621	10.17
81	90	20.41	647	13.18	1,596	10.52
91	100	21.32	632	13.46	1,615	10.87
101	110	22.02	637	14.02	1,590	11.15
111	120	22.79	628	14.30	1,618	11.57
121	130	23.28	636	14.80	1,602	11.85
131	140	23.98	638	15.29	1,578	12.06
141	150	24.40	641	15.64	1,588	12.41
151	160	25.17	636	15.99	1,579	12.62
161	170	25.80	650	16.76	1,524	12.76
171	180	26.37	649	17.11	1,550	13.25
181	190	26.79	650	17.39	1,557	13.53
191	200	27.49	638	17.53	1,593	13.95
201	220	28.40	638	18.09	1,566	14.16
221	240	29.03	638	18.51	1,599	14.80
241	260	29.66	644	19.07	1,596	15.22
261	280	30.43	643	19.56	1,621	15.85
281	300	31.06	644	19.98	1,636	16.34
301	320	31.76	652	20.69	1,634	16.90
321	340	32.47	657	21.32	1,632	17.39
341	360	33.10	664	21.95	1,636	17.95
361	380	33.66	673	22.65	1,635	18.51

Schedule C: Unaccompanied Baggage						
Applies to Points within CONUS and Hawaii						
LOW MILE	HIGH MILE	350 to 999	Break Point	1000 to 1999	Break Point	2000 & OVER
381	400	34.50	663	22.86	1,663	19.00
401	420	34.85	675	23.49	1,654	19.42
421	440	35.76	665	23.77	1,664	19.77
441	460	36.46	664	24.19	1,687	20.41
461	480	37.02	667	24.68	1,682	20.76
481	500	37.80	667	25.17	1,694	21.32
501	520	38.36	673	25.80	1,691	21.81
521	540	39.13	665	26.01	1,699	22.09
541	560	39.48	668	26.37	1,724	22.72
561	580	39.90	668	26.65	1,716	22.86
581	600	40.39	671	27.07	1,705	23.07
601	620	40.95	670	27.42	1,714	23.49
621	640	41.23	672	27.70	1,712	23.70
641	660	41.72	669	27.91	1,719	23.98
661	680	41.93	671	28.12	1,736	24.40
681	700	42.35	673	28.47	1,739	24.75
701	725	42.77	676	28.89	1,743	25.17
726	750	43.26	678	29.31	1,742	25.52
751	775	43.69	679	29.66	1,740	25.80
776	800	44.04	684	30.08	1,730	26.01
801	825	44.39	686	30.43	1,733	26.37
826	850	44.60	689	30.71	1,736	26.65
851	875	44.88	688	30.85	1,737	26.79
876	900	45.09	689	31.06	1,748	27.14
901	925	45.23	697	31.48	1,742	27.42
926	950	45.65	695	31.69	1,748	27.70
951	975	45.79	696	31.83	1,763	28.05
976	1,000	47.05	686	32.26	1,766	28.47
1,001	1,050	48.03	688	33.03	1,767	29.17

Schedule C: Unaccompanied Baggage						
Applies to Points within CONUS and Hawaii						
LOW MILE	HIGH MILE	350 to 999	Break Point	1000 to 1999	Break Point	2000 & OVER
1,051	1,100	49.58	685	33.94	1,773	30.08
1,101	1,150	50.70	687	34.78	1,775	30.85
1,151	1,200	52.17	686	35.76	1,773	31.69
1,201	1,250	53.22	683	36.32	1,784	32.40
1,251	1,300	54.34	682	37.02	1,785	33.03
1,301	1,350	55.18	687	37.87	1,786	33.80
1,351	1,400	55.89	693	38.71	1,787	34.57
1,401	1,450	56.80	697	39.55	1,774	35.06
1,451	1,500	57.43	701	40.25	1,781	35.83
1,501	1,550	58.27	703	40.95	1,781	36.46
1,551	1,600	58.76	705	41.37	1,790	37.02
1,601	1,650	59.39	705	41.86	1,803	37.72
1,651	1,700	60.09	705	42.35	1,812	38.36
1,701	1,750	60.72	711	43.12	1,815	39.13
1,751	1,800	61.29	713	43.69	1,818	39.69
1,801	1,850	62.06	716	44.39	1,805	40.04
1,851	1,900	62.55	720	45.02	1,798	40.46
1,901	1,950	63.18	723	45.65	1,804	41.16
1,951	2,000	63.95	726	46.42	1,798	41.72
2,001	2,050	64.58	729	47.05	1,789	42.07
2,051	2,100	65.28	727	47.40	1,805	42.77
2,101	2,150	65.77	731	48.03	1,811	43.47
2,151	2,200	66.40	732	48.59	1,813	44.04
2,201	2,250	67.11	733	49.15	1,815	44.60
2,251	2,300	67.46	739	49.79	1,812	45.09
2,301	2,350	67.95	738	50.14	1,816	45.51
2,351	2,400	68.58	739	50.63	1,809	45.79
2,401	2,450	69.14	742	51.26	1,812	46.42

Schedule C: Unaccompanied Baggage						
Applies to Points within CONUS and Hawaii						
LOW MILE	HIGH MILE	350 to 999	Break Point	1000 to 1999	Break Point	2000 & OVER
2,451	2,500	69.63	744	51.75	1,811	46.84
2,501	2,550	69.77	748	52.17	1,810	47.19
2,551	2,600	70.05	747	52.31	1,824	47.68
2,601	2,650	70.54	745	52.52	1,830	48.03
2,651	2,700	70.75	751	53.08	1,826	48.45
2,701	2,750	71.17	750	53.36	1,824	48.66
2,751	2,800	71.31	754	53.71	1,831	49.15
2,801	2,850	71.73	752	53.92	1,829	49.29
2,851	2,900	72.01	756	54.41	1,830	49.79
2,901	2,950	72.36	755	54.62	1,831	50.00
2,951	3,000	72.57	761	55.18	1,825	50.35
3,001	3,050	73.00	759	55.40	1,831	50.70
3,051	3,100	73.21	763	55.82	1,835	51.19
3,101	3,150	73.42	763	55.96	1,840	51.47
3,151	3,200	73.91	765	56.52	1,837	51.89
3,201	3,250	74.12	767	56.80	1,838	52.17
3,251	3,300	74.40	768	57.08	1,841	52.52
3,301	3,350	74.47	768	57.15	1,851	52.87
3,351	3,400	74.75	768	57.36	1,854	53.15
3,401	3,450	74.96	767	57.43	1,859	53.36
3,451	3,500	75.03	770	57.71	1,857	53.57
3,501	3,550	75.17	771	57.92	1,858	53.78
3,551	3,600	75.73	772	58.41	1,847	53.92
3,601	3,650	75.94	772	58.62	1,855	54.34
3,651	3,700	76.08	773	58.76	1,855	54.48
3,701	3,750	76.50	773	59.11	1,853	54.76
3,751	3,800	76.64	775	59.32	1,861	55.18

Schedule D: Unaccompanied Baggage Applies to Points within Germany						
LOW MILE	HIGH MILE	350 to 999	Break Point	1000 to 1999	Break Point	2000 & OVER
1	10	9.47	653	6.18	1,636	5.06
11	20	9.99	652	6.51	1,655	5.38
21	30	10.52	651	6.84	1,653	5.65
31	40	11.11	651	7.23	1,654	5.98
41	50	11.63	645	7.50	1,667	6.24
51	60	12.10	642	7.76	1,662	6.45
61	70	12.61	647	8.15	1,644	6.70
71	80	13.08	644	8.42	1,625	6.84
81	90	13.74	642	8.81	1,613	7.10
91	100	14.26	637	9.08	1,608	7.29
101	110	14.79	636	9.40	1,595	7.50
111	120	15.24	634	9.66	1,592	7.68
121	130	15.65	635	9.92	1,590	7.89
131	140	16.10	641	10.31	1,581	8.15
141	150	16.49	642	10.58	1,578	8.34
151	160	16.96	636	10.78	1,574	8.48
161	170	17.29	650	11.24	1,533	8.61
171	180	17.75	649	11.50	1,543	8.87
181	190	18.01	646	11.63	1,572	9.14
191	200	18.47	638	11.77	1,586	9.33
201	220	19.06	635	12.10	1,576	9.53
221	240	19.52	640	12.49	1,590	9.92
241	260	19.98	645	12.88	1,592	10.25
261	280	20.44	641	13.08	1,628	10.64
281	300	20.97	643	13.47	1,629	10.97
301	320	21.36	650	13.87	1,641	11.38
321	340	21.89	652	14.26	1,632	11.63
341	360	22.28	661	14.72	1,635	12.03
361	380	22.61	669	15.12	1,653	12.49
381	400	23.13	663	15.32	1,674	12.82
401	420	23.40	675	15.77	1,651	13.02
421	440	24.05	667	16.04	1,665	13.35
441	460	24.52	662	16.23	1,694	13.74
461	480	24.91	668	16.63	1,675	13.93

Schedule D: Unaccompanied Baggage Applies to Points within Germany						
LOW MILE	HIGH MILE	350 to 999	Break Point	1000 to 1999	Break Point	2000 & OVER
481	500	25.43	667	16.96	1,682	14.26
501	520	25.76	672	17.29	1,696	14.66
521	540	26.29	663	17.42	1,706	14.85
541	560	26.49	670	17.75	1,711	15.18
561	580	26.82	667	17.87	1,715	15.32
581	600	27.15	671	18.20	1,712	15.57
601	620	27.48	670	18.40	1,715	15.77
621	640	27.73	674	18.67	1,712	15.98
641	660	28.00	672	18.79	1,714	16.10
661	680	28.26	670	18.93	1,743	16.49
681	700	28.46	672	19.12	1,747	16.70
701	725	28.79	674	19.39	1,750	16.96
726	750	29.05	679	19.72	1,734	17.09
751	775	29.37	681	19.98	1,731	17.29
776	800	29.58	683	20.17	1,727	17.42
801	825	29.84	685	20.44	1,737	17.75
826	850	29.97	687	20.58	1,738	17.87
851	875	30.11	690	20.77	1,735	18.01
876	900	30.36	691	20.97	1,744	18.28
901	925	30.50	692	21.10	1,745	18.40
926	950	30.69	694	21.30	1,754	18.67
951	975	30.83	695	21.42	1,761	18.86
976	1,000	31.61	685	21.63	1,769	19.12
1,001	1,050	32.27	689	22.22	1,764	19.59
1,051	1,100	33.25	688	22.88	1,764	20.17
1,101	1,150	34.11	684	23.33	1,781	20.77
1,151	1,200	35.04	687	24.05	1,771	21.30
1,201	1,250	35.82	683	24.44	1,785	21.82
1,251	1,300	36.48	683	24.91	1,784	22.22
1,301	1,350	37.07	689	25.51	1,783	22.74
1,351	1,400	37.53	692	25.96	1,788	23.21
1,401	1,450	38.18	696	26.56	1,773	23.53
1,451	1,500	38.58	699	26.95	1,790	24.12
1,501	1,550	39.11	703	27.48	1,785	24.52

Schedule D: Unaccompanied Baggage						
Applies to Points within Germany						
LOW MILE	HIGH MILE	350 to 999	Break Point	1000 to 1999	Break Point	2000 & OVER
1,551	1,600	39.50	704	27.81	1,792	24.91
1,601	1,650	39.97	706	28.20	1,800	25.37
1,651	1,700	40.42	705	28.46	1,810	25.76
1,701	1,750	40.81	709	28.92	1,819	26.29
1,751	1,800	41.20	713	29.37	1,817	26.68
1,801	1,850	41.67	717	29.84	1,802	26.88
1,851	1,900	42.06	721	30.30	1,797	27.21
1,901	1,950	42.46	723	30.69	1,804	27.67
1,951	2,000	42.92	726	31.16	1,798	28.00
2,001	2,050	43.38	729	31.61	1,793	28.33
2,051	2,100	43.83	728	31.88	1,807	28.79
2,101	2,150	44.30	729	32.27	1,813	29.25
2,151	2,200	44.69	731	32.66	1,812	29.58
2,201	2,250	45.02	733	32.99	1,817	29.97
2,251	2,300	45.35	737	33.39	1,819	30.36
2,301	2,350	45.68	739	33.72	1,813	30.56
2,351	2,400	46.07	740	34.05	1,811	30.83
2,401	2,450	46.46	742	34.44	1,810	31.16
2,451	2,500	46.79	745	34.83	1,808	31.48
2,501	2,550	46.93	747	35.04	1,813	31.75
2,551	2,600	47.06	748	35.16	1,825	32.08
2,601	2,650	47.45	744	35.29	1,829	32.27
2,651	2,700	47.59	751	35.69	1,827	32.60
2,701	2,750	47.78	752	35.88	1,825	32.74
2,751	2,800	47.92	754	36.09	1,829	32.99
2,801	2,850	48.18	753	36.28	1,827	33.13
2,851	2,900	48.43	755	36.54	1,828	33.39
2,901	2,950	48.64	757	36.81	1,829	33.65
2,951	3,000	48.76	761	37.07	1,827	33.85
3,001	3,050	49.03	760	37.26	1,832	34.11
3,051	3,100	49.17	762	37.46	1,836	34.38
3,101	3,150	49.29	763	37.59	1,843	34.63
3,151	3,200	49.69	765	37.99	1,837	34.90
3,201	3,250	49.82	767	38.18	1,836	35.04

Schedule D: Unaccompanied Baggage						
Applies to Points within Germany						
LOW MILE	HIGH MILE	350 to 999	Break Point	1000 to 1999	Break Point	2000 & OVER
3,251	3,300	50.01	768	38.39	1,839	35.29
3,301	3,350	50.08	768	38.45	1,843	35.43
3,351	3,400	50.22	767	38.51	1,857	35.76
3,401	3,450	50.34	767	38.58	1,861	35.88
3,451	3,500	50.48	770	38.84	1,851	35.95
3,501	3,550	50.61	771	38.98	1,855	36.15
3,551	3,600	50.87	772	39.23	1,850	36.28
3,601	3,650	51.00	772	39.37	1,853	36.48
3,651	3,700	51.14	773	39.50	1,858	36.68
3,701	3,750	51.33	774	39.70	1,858	36.87
3,751	3,800	51.53	775	39.89	1,859	37.07

Schedule E: Unaccompanied Baggage						
Applies to Points other than Germany, Hawaii, and Alaska						
LOW MILE	HIGH MILE	350 to 999	Break Point	1000 to 1999	Break Point	2000 & OVER
1	10	5.82	638	3.71	1,690	3.13
11	20	6.13	639	3.91	1,699	3.32
21	30	6.45	637	4.11	1,683	3.46
31	40	6.84	649	4.44	1,645	3.65
41	50	7.17	646	4.63	1,664	3.85
51	60	7.50	636	4.76	1,643	3.91
61	70	7.76	631	4.89	1,683	4.11
71	80	8.08	638	5.15	1,645	4.24
81	90	8.41	644	5.41	1,612	4.36
91	100	8.80	630	5.54	1,625	4.50
101	110	9.06	641	5.80	1,594	4.63
111	120	9.39	632	5.93	1,582	4.69
121	130	9.65	636	6.13	1,596	4.89
131	140	9.90	638	6.32	1,588	5.01
141	150	10.10	646	6.52	1,581	5.15
151	160	10.43	638	6.64	1,570	5.21

Schedule E: Unaccompanied Baggage						
Applies to Points other than Germany, Hawaii, and Alaska						
LOW MILE	HIGH MILE	350 to 999	Break Point	1000 to 1999	Break Point	2000 & OVER
161	170	10.63	644	6.84	1,561	5.34
171	180	10.88	648	7.04	1,556	5.48
181	190	11.08	648	7.17	1,563	5.60
191	200	11.34	638	7.23	1,588	5.74
201	220	11.73	639	7.50	1,566	5.87
221	240	11.99	636	7.62	1,609	6.13
241	260	12.26	649	7.95	1,575	6.25
261	280	12.58	643	8.08	1,628	6.58
281	300	12.83	645	8.27	1,670	6.91
301	320	13.16	649	8.54	1,633	6.97
321	340	13.42	656	8.80	1,630	7.17
341	360	13.69	658	9.00	1,652	7.43
361	380	13.95	669	9.33	1,635	7.62
381	400	14.21	665	9.45	1,669	7.88
401	420	14.40	671	9.65	1,663	8.02
421	440	14.73	669	9.84	1,669	8.21
441	460	15.05	663	9.98	1,686	8.41
461	480	15.38	666	10.23	1,670	8.54
481	500	15.64	667	10.43	1,688	8.80
501	520	15.84	671	10.63	1,694	9.00
521	540	16.17	662	10.69	1,707	9.12
541	560	16.29	668	10.88	1,715	9.33
561	580	16.49	676	11.14	1,697	9.45
581	600	16.68	680	11.34	1,689	9.58
601	620	16.88	680	11.47	1,684	9.65
621	640	17.07	676	11.53	1,696	9.78
641	660	17.21	675	11.61	1,707	9.90
661	680	17.33	677	11.73	1,723	10.10
681	700	17.53	673	11.79	1,735	10.23
701	725	17.66	698	12.32	1,693	10.43
726	750	17.86	679	12.12	1,732	10.49
751	775	18.05	680	12.26	1,735	10.63
776	800	18.19	681	12.38	1,727	10.69
801	825	18.31	688	12.58	1,730	10.88

Schedule E: Unaccompanied Baggage						
Applies to Points other than Germany, Hawaii, and Alaska						
LOW MILE	HIGH MILE	350 to 999	Break Point	1000 to 1999	Break Point	2000 & OVER
826	850	18.30	692	12.66	1,739	11.00
851	875	18.53	689	12.75	1,743	11.11
876	900	18.66	691	12.88	1,744	11.23
901	925	18.76	693	12.99	1,746	11.33
926	950	18.90	694	13.11	1,748	11.46
951	975	18.98	697	13.21	1,758	11.61
976	1,000	19.44	685	13.30	1,772	11.78
1,001	1,050	19.85	689	13.66	1,766	12.06
1,051	1,100	20.46	687	14.04	1,770	12.42
1,101	1,150	20.99	684	14.35	1,777	12.75
1,151	1,200	21.55	686	14.76	1,776	13.11
1,201	1,250	22.02	683	15.03	1,784	13.40
1,251	1,300	22.47	684	15.37	1,779	13.66
1,301	1,350	22.79	689	15.69	1,782	13.98
1,351	1,400	23.11	693	16.01	1,778	14.23
1,401	1,450	23.49	696	16.33	1,775	14.49
1,451	1,500	23.75	700	16.61	1,783	14.80

Schedule F: Unaccompanied Baggage						
Applies to Points within Alaska						
LOW MILE	HIGH MILE	350 to 999	Break Point	1000 to 1999	Break Point	2000 & OVER
1	15	17.39	678	11.78	1,584	9.33
16	20	18.16	680	12.34	1,569	9.68
21	30	19.00	672	12.76	1,583	10.10
31	40	19.98	664	13.25	1,588	10.52
41	50	20.97	663	13.88	1,576	10.94
51	60	35.34	649	22.93	1,566	17.95
61	70	35.62	656	23.35	1,562	18.23
71	80	36.11	653	23.56	1,566	18.44
81	90	36.32	653	23.70	1,569	18.58
91	100	36.74	653	23.98	1,556	18.65
101	110	37.02	656	24.26	1,561	18.93
111	120	37.51	651	24.40	1,564	19.07
121	130	37.80	654	24.68	1,557	19.21
131	140	38.08	652	24.82	1,582	19.63
141	150	38.36	653	25.03	1,592	19.91
151	160	38.85	649	25.17	1,588	19.98
161	170	39.20	655	25.66	1,569	20.12
171	180	39.62	655	25.94	1,573	20.41
181	190	39.90	658	26.23	1,578	20.69
191	200	40.25	656	26.37	1,575	20.76
201	220	40.60	655	26.58	1,578	20.97
221	240	41.09	656	26.93	1,573	21.18
241	260	41.37	660	27.28	1,558	21.25
261	280	41.79	662	27.63	1,554	21.46
281	300	42.21	658	27.77	1,551	21.53
301	320	42.56	659	28.05	1,541	21.60
321	340	42.84	667	28.54	1,529	21.81
341	360	43.26	667	28.82	1,519	21.88
361	380	43.62	666	29.03	1,513	21.95
381	400	43.76	669	29.24	1,506	22.02
401	420	44.11	668	29.45	1,500	22.09
421	440	44.39	669	29.66	1,495	22.16
441	460	44.60	672	29.94	1,481	22.16
461	480	44.88	672	30.15	1,475	22.23

Schedule F: Unaccompanied Baggage						
Applies to Points within Alaska						
LOW MILE	HIGH MILE	350 to 999	Break Point	1000 to 1999	Break Point	2000 & OVER
481	500	44.95	673	30.22	1,495	22.58
501	520	45.58	673	30.64	1,488	22.79
521	540	46.28	670	30.99	1,503	23.28
541	560	46.91	675	31.62	1,491	23.56
561	580	47.40	674	31.90	1,491	23.77
581	600	48.03	673	32.33	1,502	24.26
601	620	48.52	671	32.54	1,509	24.54
621	640	49.15	671	32.96	1,507	24.82
641	660	49.93	668	33.31	1,508	25.10
661	680	49.93	673	33.59	1,529	25.66
681	700	50.35	677	34.08	1,523	25.94
701	725	50.91	681	34.64	1,519	26.30
726	750	51.33	684	35.06	1,520	26.65
751	775	51.75	685	35.41	1,525	27.00
776	800	52.24	686	35.83	1,527	27.35
801	825	52.52	689	36.18	1,535	27.77
826	850	53.01	692	36.67	1,549	28.40
851	875	53.29	693	36.88	1,567	28.89
876	900	53.78	694	37.30	1,579	29.45
901	925	53.99	698	37.65	1,591	29.94
926	950	54.34	700	38.01	1,595	30.29
951	975	54.62	701	38.29	1,609	30.78
976	1000	55.04	701	38.57	1,630	31.41

1. The break point represents weights at which the minimum weight in the next higher weight column times the rate in that weight column, produces a lower charge than the actual weight of the shipment times the applicable rate in such rate section.
 - a. The linehaul transportation charge for a shipment shall not exceed the charge that would apply by use of the next greater unit of weight at rate applicable in the next higher rate bracket.
 - b. To illustrate the break point:
 - (1) Shipment weighs 3,450 lbs., moving 510 miles. Under Schedule A the rate would be 3,450 lbs. x \$24.27 per cwt = \$837.32.
 - (2) Using the lowest weight in the next weight bracket (4,000 lbs.) x the rate in that bracket (\$19.62) = \$784.80.
 - (3) The correct charge for the above shipment is the lower of the two computations, namely \$784.80.

Item 531 – Reserved for Future Use

Item 532 - Excessive Distance Carry Charges To/From Residence or Mini-Storage Warehouse

(532A) - Long Carry at Residence or Mini-Storage Warehouse

1. TSP may invoice for an excessive distance carry charge in the following cases when pre-authorization has been received from the JPPSO/PPSO (e.g., e-mail correspondence, system notes, etc.):
 - a. Long carry from/to residence is over 75 feet between the TSP's vehicle and entrance door to the residence due to construction or other safety factors which prevent normal carry access to the residence.
 - b. Long carry involving a mini-storage warehouse if a pickup or delivery involves carries of more than 75 feet between the TSP's vehicle and entrance door to the actual storage unit where HHGs are physically located.
2. CONUS: See State GBLOC Item 500 table for the geographical application of rate schedules.
3. OCONUS: **\$1.33** cwt

Item 533 - Miscellaneous Charge

(533A) - Miscellaneous Charge

1. Any authorized charge incurred by the TSP, which is not covered by any other designated service code and not performed by a third-party service, will be billed as a miscellaneous charge.
2. All miscellaneous charges must be accompanied by a detailed note providing a description of the service rendered and explaining why TSP is using this item code.

Item 534 - Third Party Service Charge

(TPS) - Third Party Service Charge

1. When the services of a third party are required to service articles (including disassembly and assembly) of an unusual nature, the TSP will, at the written request of the PPSO, arrange for such servicing. Payment for services of a third party will be advanced by the TSP and billed as an advanced charge. The charge will be supported by the PPSO's authorization and by the third-parties invoice.
2. This item applies when pre-approval has been provided by the PPSO for the TSP to obtain services for the completion of the move. These services include, but are not limited to third-party charges, parking permits, and any other services not otherwise identified in this Tender but requested and approved by the PPSO as necessary for the completion of the move.
 - a. All such third-party charges will be supported by paid receipts and apply in addition to all other applicable Tender charges provided that pre-approval for services has been authorized.
3. When the origin or destination of the shipment, or a portion thereof, is located at a point accessible only by the use of a ferry, the following provisions apply:
 - a. When TSPs normal linehaul equipment cannot be accommodated by the ferry system, shuttle service will be provided, subject to the charge and provisions in Item 501.
 - b. Waiting time charges as provided in Item 503 will apply commencing with the arrival of the TSP's vehicle at the ferry point of embarkation, during the vehicle crossing, and terminating when the vehicle disembarks from the ferry. The allowable free waiting time provisions provided for in Item 503 will not apply during the ferry waiting and transportation period described herein.
4. FSC is not authorized and shall not be billed or paid on third-party service.
5. Third-party service does not apply to washers (e.g., front load) and other household articles that require bracing/stabilization (and unbracing/destabilization) of moveable parts in or on such appliances. The cost of this service is considered to be part of the TSPs SFR.
6. Crating is not authorized a third-party service charge. When crating is accomplished in combination with a third party (i.e., pool table disassembly), the TSP will be reimbursed for the cost of the crate, not to exceed the authorized cost for same crate size utilizing Item 508. The TSP must provide documentation identifying the crate dimensions and separate costing for the crate. TSPs must bill the appropriate item code and will only be paid according to the charges in Item 508.
7. When an article cannot be picked up or delivered from a residence by the conventional method (doorways, stairs, elevator to floor) or the structural nature of the residence must be changed to accommodate a pickup or delivery (removal of windows, doors, etc.), the TSP, upon approval of the PPSO will be authorized third-party service or labor rates under Item 502, if performed by a local agent. This exception is directed at the pickups and deliveries from high rise apartment buildings (higher than 2 floors) and is not intended to be used for minor hoisting and lowering, such as first floor balconies in apartments and single-family dwellings.

- a. In cases where an elevator is not in working order in high rise buildings, the TSP, upon approval by the PPSO, may be authorized labor rates under Item 502, if performed by a local agent.

Chapter 6 - Billing and Payment

Purpose

This chapter pertains to billing and payment procedures for all international shipments.

Item 600 - Billing and Payment Requirements

1. The DoD approved Third Party Payment System (TPPS) and the use of DPS is mandatory for all transactions and payments for shipments moving under this Tender.
2. Currently, the TPPS does not have the capability to process administrative offsets under the provisions of 31 USC 3716.
 - a. By accepting shipments, the TSP gives consent for
 - (1) a representative of the DoD, GSA, or USCG to access TPPS, generate, and approve electronic bills (eBills) in lieu of an administrative offset under 31 USC 3716, and
 - (2) agrees to hold the DoD approved TPPS, or a successor administrator of TPPS, harmless for any eBills approved, paid, or collected under this provision.
 - (3) Approved eBills paid or collected under these provisions by the DoD, GSA, or USCG shall be treated as an administrative offset for the purpose of appeals and refunds.

Item 601 - Billing Instructions

1. Electronic Funds Transfer (EFT) Payment:
 - a. Method of Payment: Payments processed by the DoD approved TPPS, including invoice and BLs payments, may be made by EFT at the option of the TPPS.
 - b. Mandatory Submission of TSP's EFT Information:
 - (1) The TSP is required to provide the TPPS with EFT information required to make payment as described in paragraph 2 unless the payment office determines that submission of the information is not required.
 - (a) If more than one payment office is named, the TSP shall provide a separate notice to each office.
 - (b) In the event that the EFT information changes, the TSP shall be responsible for providing the change to the TPPS.
 - (2) If the TSP provides EFT information applicable to multiple BLs, the TSP shall specifically state the applicability of this information in terms acceptable to the payment office.
2. Required EFT Information: The DoD approved TPPS makes payments as noted in the Trading Partner Agreement with TSP. The TSP shall provide the following information for both methods in a form acceptable to the designated payment office.
3. View additional information and guidance on the billing and payment requirements under this Tender at: https://www.ustranscom.mil/dtr/part-iv/dtr_part_iv_app_a.pdf.

Chapter 7 - One-Time-Only Procedures for INTL HHG, UB, and Boat Shipments

Purpose

The following guidelines provide procedures and instructions for DPS One-Time-Only (OTO) shipments and the OTO SFR request for quote (RFQ) Solicitation and Award process for International Household Goods (iHHG), Unaccompanied Baggage (iUB), and qualified Boat One-Time-Only (iBOTO) shipments.

Item 700 - Criteria for Use of OTO Rates

1. OTO procedures will apply under the following conditions:
 - a. When origin rate area to destination rate area SFR are not solicited under the DPS International Standard or Special Solicitation (SS) program channels.
 - b. When a shipment with accepted rates on file is diverted to or from a rate area where there are no accepted rates on file for the applicable rate cycle and channel.
 - c. When a shipment requires conversion (e.g., from Code 7 to Code 8 service) due to strike or other conditions which impedes timely service and the TSP to which the shipment was tendered does not offer alternate rates in the converted service.
 - d. When a shipment requires reshipment under conditions specified in Chapter 5 of this Tender.
 - e. OTO shipments awarded to a TSP are not authorized a diversion.
 - f. When a TSP is awarded and accepts a shipment on a channel where it has no effective rate on file, acceptance constitutes an agreement by the TSP to perform the transportation services at the rate negotiated under these procedures.
 - g. Where HHG movement is to, from, or between OCONUS (including Alaska & Hawaii) locations and the combined boat/trailer dimensions exceeds the below dimensions or will not fit into a standard HHG ocean container.
 - (1) If authorized, boats or personal watercraft (including but not limited to canoes, kayaks, dinghies, rowboats, jet skis, and sculls) with or without an associated trailer that exceed the following dimensions shall be moved via the OTO program:
 - 1 Length=14 feet (168 inches)
 - 2 Width=6 feet 10 inches (82 inches)
 - 3 Height=6 feet 5 inches (77 inches)
 - (2) When shipping a boat with a trailer, the overall dimensions of the boat on the trailer as a single unit must be provided, as illustrated below. Please provide this information in the Additional Remarks field during counseling.

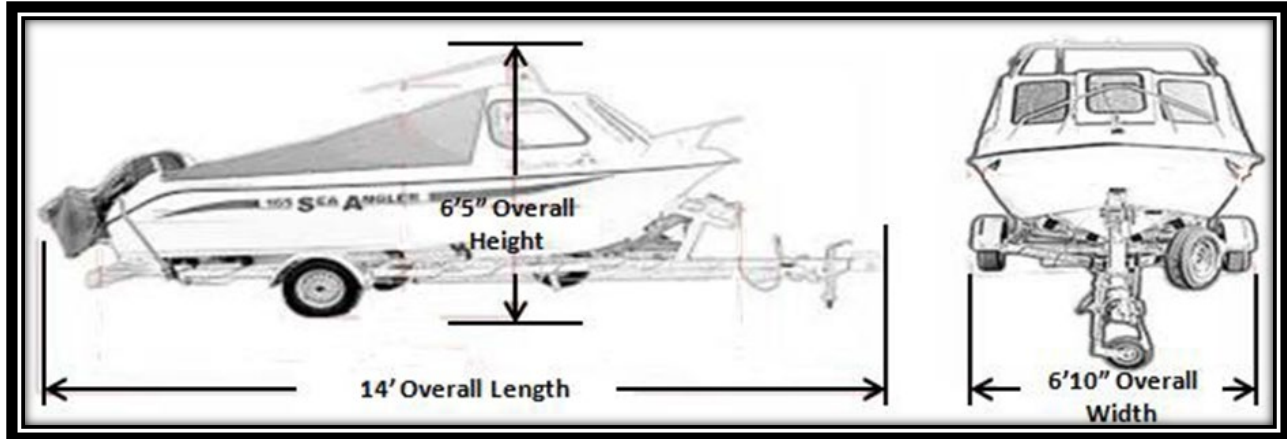

- (3) When a boat is moved and the customer is also shipping HHG to the same destination, the **boat and HHG will be combined into one shipment and moved as a Boat shipment with HHG.**
 - (4) In order for a civilian employee to ship a boat/personal watercraft at Government expense, the overall measurement of the boat/personal watercraft with or without its associated trailer cannot exceed 18 feet in length.
 - (5) If pre-approval is requested by the awarded TSP and approval is granted by the PPSO, an authorized boat/personal watercraft may be crated utilizing Item Code 508C and moved with the customer's HHG shipment under the TSP's OTO SFR.
2. Crating for items pertaining to HHG shipments or the HHG portion of an iBOTO is an assessorial not included in the TSP's OTO SFR.
 - a. TSP must submit a request for crating to the PPSO before performing any services.
 - b. PPSO reserves the right to approve or disapprove based on all supporting facts provided by the TSP.
 3. Boat Flat Rate: Associated crating costs will be included within the TSP's boat flat rate bid.
 4. Under certain circumstances, USTRANSCOM may agree to terminate the shipment, especially when the shipment remains at origin or has not proceeded beyond the POE. However, when termination is approved, the TSP agrees to reimbursement only for costs incurred to the point of termination, as contained in Chapter 5 of this Tender.
 5. Refer to Chapter 12 for all Department of State (DoS) Arranged Moves.

Item 701 - Procedures

1. The following procedures and guidelines are applicable to OTO shipments.
 - a. When the criteria within Item 700 are met,
 - (1) the PPSO may create OTO shipments within DPS and
 - (2) submit to USTRANSCOM within 7 GBDs of the requested pickup date.
 - (3) In the event a requested shipment pickup date is less than 7 GBDs, PPSOs must provide an alternate means of pickup (designated Origin Agent) at the time of submission.

-
- b. Authorization is required from a Service Representative before requesting an estimated bid for a Personally Procured Move (PPM) on an OTO channel (excluding mail or small package service).
 - c. In the event a shipment is offloaded at a port other than the port designated, the provisions covering alternate ports will apply.
 - d. OTO solicitation requirements:
 - (1) Solicitation starts and end times will be open for bidding for OTO and/or BOTO qualified and approved TSPs.
 - (2) Shipments are independently solicited and are subject to change to meet mission requirements.
 - (3) If a TSP experiences problems with bidding during the active solicitation window, they are required to contact the USTRANSCOM PP Special Requirements & Rates Team prior to the expiration of the solicitation suspense date and time.
 - (4) Shipments will be solicited at approximately 1000 hours on GBDs, subject to change based on mission requirements.
 - (5) TSP bids must be submitted by 1300 hours on the specified solicitation suspense date/time. Suspense date/time may be subject to change based on mission requirements.
 - (6) Communication and disputes between TSPs and agents are the responsibility of the bidding and awarded TSP; please refer to USTRANSCOM TSP Qualifications.
 - (7) TSPs are required to factor in all associated costs in the application of the TSP's OTO SFR IAW shipment solicitation criteria per bid as listed below:
 - (a) Fuel Related Adjustment (including CONUS, AK, and HI).
 - (b) Bunker Surcharge (BSC).
 - (c) Port Security Surcharge.
 - (d) War Risk Surcharge.
 - (e) Air Fuel Surcharge (Item 231A).
 - (f) TSPs are required to factor in all agent/carrier-imposed minimums within their bids.
 - (8) Fuel Related Adjustment is NOT included in the SFR for shipments delivering in or out of storage in CONUS and non-foreign OCONUS (Hawaii, Alaska).
 - (9) If U.S. Flag (USF) carriers are used in current OTO bids,
 - (a) each bid must include the required routing and carrier information in order to be considered a valid bid,
 - (b) any origin or destination foreign flag (F/F) feeders within a USF routing claim will not be considered a valid USF routing claim and will be considered a F/F route.

-
- (10) During the bidding process, bids will include whether USF service will be identified and provided. TSPs claiming USF only will be required to provide the following information/modes of transport from origin to final destination:
 - (a) Air (to include Airline and flight number).
 - (b) Water (to include vessel name).
 - (c) Land.
 - (d) Carrier (to include flight number and/or vessel name).
 - (e) Routing information.
 - (11) Acceptance of a bid with F/F routing does not grant F/F approval. Refer to Item 221 for F/F request guidelines and procedures.
 - (12) Air shipments moving between overseas areas are exempt from having to obtain an F/F certificate.
 - (13) F/F approval must be obtained when:
 - (a) The use of an aircraft of United States registry will not provide the required service during any segment of the routing to or from the United States, or
 - (b) The use of a USF ocean vessel will not provide the required service on shipments to, from, and between all overseas ocean ports with no exception.
 - (14) OTO bids submitted with "SUBJECT TO AVAILABILITY" in the routing details and remarks section are not valid and will not be considered.
- e. TSPs must enter their Tender Number and accept the OTO shipment award within 24 hours in DPS OTO application once they have received an OTO shipment award notification.
 - f. TSPs are responsible for the proper review of
 - (1) DPS shipment details,
 - (2) research,
 - (3) timely coordination, and
 - (4) accurate submission of their OTO bids.
2. TSPs must submit OTO bids based upon the use of agents/warehouses approved for use by either the DoD or DoS for the applicable overseas area.
 - a. TSPs are responsible for validating the selected DoD/DoS warehouse(s) is/are approved in DPS prior to placing their bid.
 - b. DoS agents/warehouses are only to be used when no DoD agent/warehouse is available in the applicable overseas area.
 - (1) Awarded TSPs may change their agents as long as the selected agent is DoD/DoS approved and the TSPs SFR does not change.
 - c. USTRANSCOM reserves the right to change and update the known agent listing based on DoD/DoS inputs at any time.

(1) In the event DoD/DoS places a known agent in non-use status, TSPs using that agent must acquire a DoD/DoS approved replacement agent as stated above.

3. Turnbacks are not authorized, and TSP is subject to administrative action.

Item 702 - Mistake in Rate Filing

1. All Mistakes in Rate Filing (MIRF) must be in accordance with the following guidelines and criteria.
 - a. The solicitation and awarding of OTO shipments is considered a sealed bidding process.
 - b. Once an OTO shipment solicitation suspense date has expired, TSPs may not be allowed to change or withdraw their bid.
 - c. An approved TSP that is awarded a shipment may submit a MIRF, but NLT than 1300 hours on the next business day of shipment award. The following exceptions apply when the awarded TSP provides clear and convincing evidence that shipment solicitation information
 - (1) contained errors that affect the character of the shipment.
 - (2) error was so obvious that the Government should have noticed prior to award.
2. In such instances, USTRANSCOM may
 - a. cancel the solicitation,
 - b. grant a MIRF,
 - c. authorize a rate revision, or
 - d. remove all TSP bids and re-solicit for bids based on changes to shipment criteria.
3. A MIRF will not be allowed for the following reasons:
 - a. Administrative errors.
 - b. Improper calculations.
 - c. Errors in judgment.
 - d. Using incorrect logistical calculations.
4. TSPs shall not be permitted to claim a MIRF for iHHG and/or iUB based on estimated, actual, or minimum shipment weight differential guidelines as stated below in Item 703 paragraph 1.b.

Item 703 - Rate Revision Requests

1. All Rate Revision Requests (RRR) are handled with USTRANSCOM and must be in accordance with the following guidelines and criteria.
 - a. JPPSO/PPSOs shall properly estimate the weight of each shipment prior to submitting request to USTRANSCOM.
 - b. TSPs acknowledge that they are submitting bids based upon an estimated weight, and that variances between the estimated weight and actual weight may occur. All weight differences will be calculated using the difference between estimated solicited weight and actual or minimum weights (IAW Item 201).

-
- c. USTRANSCOM reserves the right to
 - (1) reject any revised bid,
 - (2) re-solicit for bids, or
 - (3) cancel an OTO shipment solicitation.
 - d. TSPs are required to submit all requests using the OTO RRR Form. This form may be obtained by sending an e-mail to transcom.scott.tcj9.mbx.pp-rates-oto@mail.mil.
 - e. Individual RRRs will only be considered when all of the following conditions and timelines are met:
 - (1) Upon pre-move survey, if it is determined the new estimated weight exceeds the thresholds (e.g., decreases more than the percentage differentials set forth below).
 - (2) A request to withdraw or revise a bid is submitted no later than:
 - (a) 3 calendar days after the pre-move survey or 5 calendar days prior to pickup of the shipment, whichever is earlier.
 - (b) 3 calendar days after actual pickup date for shipments awarded with less than a 7-day notice.
 - (3) All applicable shipment documentation and written justifications (facts and data) are required to support RRR and claims.
 - (4) Within 10 calendar days of the OTO Award Date (if property is in storage) or solicited shipment pickup date, whichever is earlier, TSPs must provide an official/certified weight ticket that validates the below (paragraph (7) (a) – (d)) weight differentials have been exceeded or not achieved for HHG and UB shipments. Failure to comply will negate any RRR.
 - (5) Upon request, TSP will provide a detailed line-item breakdown of all expenses associated with the shipment and justification for the rate revision.
 - (6) Rates shall fully incorporate all differentials (including cost reductions) between estimated and actual weights that do not exceed the differentials set forth.
 - (7) All TSP requests for rate revisions will be denied unless the differentials between the estimated weight and the actual or minimum weights exceed the limits below. Guidelines greater than a:
 - (a) 35% negative iHHG wt. difference up to 7,000 lbs. of estimated wt.
 - (b) 45% negative iHHG wt. difference for over 7,000 lbs. of estimated wt.
 - (c) 35% negative iUB wt. differences up to 500 lbs. of estimated wt.
 - (d) 40% negative iUB wt. difference for over 500 lbs. of estimated wt.
 - (8) USTRANSCOM reserves the right to terminate the shipment or authorize OTO SFR and/or Boat Flat Rate revisions on shipments that incur special circumstances (e.g., unidentified motorcycles, significant boat dimension differentials, etc.) impacted by OTO shipment criteria changes.

- (9) Profits/profit margins are not to be inflated in a Rate Revision Request. TSP is subject to administrative action up to and including suspension.
- f. Request forms submitted will not be considered or approved if
- (1) it does not meet the above market and weight difference criteria, or
 - (2) any required shipment data is missing.
2. Requests must be submitted to transcom.scott.tcj9.mbx.pp-rates-oto@mail.mil for review, validation, and decision. Failure to meet all request requirements may result in denial. USTRANSCOM reserves the right to terminate the shipment at origin, and re-solicit rates based upon the certified original weight ticket.
 3. Bids submitted by TSPs shall incorporate all costs for delivery to a destination within a 50-mile radius from the destination designated on the BL at no additional cost to the Government.
 4. For direct deliveries with delivery further than a 50-mile radius from the location indicated at the time of award on the BL, compensation may be based on Item 526 and 530 of this Tender.
 5. Any determination for additional compensation for delivery out of SIT is limited to that indicated in Items 520, 521, 526, and 530 and shall in no event be based on distances measured from the original point of origin to the actual delivery location.

Item 704 - TSP iOTO/iBOTO Qualifications and Quality Assurance

1. Refer to the DTR Part IV, Chapter 405 (Quality Assurance) and the USTRANSCOM TSP Qualifications located at: <https://www.ustranscom.mil/dp3/pdfs.cfm>.
2. TSP OTO Qualifications:
 - a. In addition to the USTRANSCOM TSP Qualifications International markets, TSP must have at least 1 year of continuous service as a DoD-approved International TSP and comply with the stipulations below in order to participate in the OTO program.
 - b. Must have had a satisfactory performance score within the INTL iHHG and/or iUB markets during the annual (12 month) rate cycle. Satisfactory performance is defined as a performance score above the minimum performance score (MPS) set for that specific rate cycle (see Item 220).
 - c. Request OTO and/or BOTO market approval within TSP Qualifications Forms > ETOSSS Tab.
 - d. Enter a TSP International OTO e-mail Address within Qualifications Forms > e-mail Manager Tab.
 - e. Provide required additional boat insurance for the iBOTO Market.
 - f. Receive USTRANSCOM approval and an activation date.
3. TSP Quality Assurance:
 - a. TSPs requesting approval and actively participating in the OTO/BOTO market(s) will be required to meet all applicable DTR Part IV requirements and guidelines.

- b. TSPs must maintain quality assurance standards and should understand administrative actions may be taken when violations occur.
- c. PPSOs or any affected party that have information on quality assurance related failures occurring in conjunction with OTO shipments should submit information along with all pertinent details, to the USTRANSCOM PP Operational & Quality Support Team at transcom.scott.tcj9.mbx.pp-perf@mail.mil for review and possible action.
 - (1) The e-mail shall contain the
 - (a) OTO # annotated in e-mail subject line,
 - (b) BL #,
 - (c) customer's name,
 - (d) current disposition, and
 - (e) a description of any existing issues.

Chapter 8 - Solicitation for Frustrated Shipments

Purpose

These provisions will be used to solicit OTO rates for personal property shipments, both HHG and UB that become frustrated because of nonpayment of ocean charges.

Item 800 - Ports

1. Rates will be solicited for the following ports:
 - a. CONUS: Baltimore, Charleston, Houston, Jacksonville, Los Angeles (includes Long Beach), Miami, New Orleans, New York, Norfolk, San Francisco (includes Oakland), Savannah, Seattle, and Toledo.
 - b. OVERSEAS: Algeciras, Antwerp, Balboa, Bremerhaven, Cadiz, Catania, Cristobal, Felixstowe, Glasgow, Holy Loch, Hagatna, Honolulu, Inchon, Iraklion, Iskenderun, Istanbul, Izmir, La Maddalena, Leghorn, Naha, Naples, Piraeus, Pusan, Rota, Rotterdam, San Juan, Yokohama, Yokosuka.

Item 801 - Rates - HHG

1. Rates for HHG will be stated as an SFR.
2. Rate must include costs for
 - a. port handling fees,
 - b. linehaul from port to destination, and
 - c. destination services (other than SIT) and associated costs.
3. Not included in the rate:
 - a. SIT,
 - b. warehouse handling, and
 - c. delivery out of SIT.

Item 802 - Rates - UB

1. Rates for UB will be stated as an SFR.
2. Rates must include costs for
 - a. port handling fees,
 - b. linehaul from port to destination, and
 - c. destination services (other than SIT) and associated costs.
3. Not included in the rate:
 - a. SIT,
 - b. warehouse handling, and
 - c. delivery out of SIT.
4. No additional additives will apply to UB shipments.

Item 803 - Awards

Shipments will be awarded IAW Standard and OTO market guidelines and procedures based on the rate area and channel designation from geographical port location to final destination.

Item 804 - Payment Responsibility

1. TSPs will be responsible for payment of ocean charges to either ocean TSP or TSP paying total ocean charges, as required.
 - a. Bids will not include these costs.
 - b. TSP will bill through DPS for their portion of the ocean charges as a third-party service supported by proper documentation.
 - c. TSPs will be responsible for payment of demurrage for the entire ocean container if original TSP was responsible.
2. Collection from other TSPs will be the responsibility of the TSP.
 - a. TSPs are required to maintain records identifying all charges associated with demurrage and
 - b. report same to USTRANSCOM upon request.
3. TSPs will be required to obtain new weight tickets and will bill on the new weight. The weight of the original shipment will have no bearing on the new shipment.

Item 805 - Return of TSP Equipment

TSPs will be responsible for notifying original TSP's agent that property (e.g., containers, etc.) is available for pickup upon delivery of shipment.

Item 806 - Reporting Operational Problems

TSPs must notify USTRANSCOM, ATTN: J9, when any problems occur such as failure to obtain BL from PPSO or failure to obtain release of shipment from ocean TSP.

Item 807 - Standards

1. Shipments are subject to all provisions and rules contained in this Tender and in the TOS.
2. Awards to TSPs failing to provide timely movement of property will be terminated and the TSPs will be removed from the OTO program unless failure is through no fault of the TSP.

Item 808 - Announcement for Bids

1. When it becomes necessary to obtain bids for the movement of frustrated shipments, USTRANSCOM will issue a message through DPS announcing the effective dates and name(s) of the involved TSPs.
2. The estimated volume of property to be moved will be provided in the announcement, if known.
3. The deadline for submission of bids will also be contained in the message.

Item 809 - Submission of Bids

Bids may be submitted for all ports for both HHG and UB or TSPs may choose only those ports and commodity they desire to serve. Rate filing format is provided in the Rate Filing Instructions.

Chapter 9 - Volume Moves Procedures

Purpose

1. Unless otherwise stated, all portions of this Tender apply to Volume Moves (VM).
2. This chapter provides the procedures, formats, and other information required for TSPs to file voluntary individual rate tenders (IRTs) to transport DoD and USCG sponsored VM CONUS to/from OCONUS (to include Alaska-UB only) and OCONUS to/from OCONUS.
3. These instructions supersede all previously published procedures, formats, and other information for IRT filings applicable to VM shipments.
4. Rates submitted for VM are the only time that two rates for a TSP will be permitted to be filed with USTRANSCOM from and to the same origin/destination and COS combination (i.e., one rate for the VM and another rate for regular channel).

Item 900 - Criteria for Use of Volume Move Rates

1. VM procedures will apply under the following conditions:
 - a. Estimated tonnage:
 - (1) HHG totaling 200,000 net lbs. or more.
 - (2) UB totaling 50,000 gross lbs. or more.
 - b. PPSOs having special operational requirements may request a VM for lesser amounts (for example: U.S. Army COHORT moves, base closure, etc.).
 - (1) Although every effort is made to ensure personnel and tonnage estimates are accurate as possible, there is no guarantee on number of shipments or tonnage for any VM.
 - c. Movement is from one origin (within 75 miles) to one destination (within 75 miles). GBLOCs within the 75-mile radius, other than the original GBLOC that created the VM, are authorized to process VM shipments if in support of projected shipment volumes in original VM solicitation(s).
 - d. Requests must be entered into DPS and submitted to USTRANSCOM at least 90 days prior to the requested start date of the VM. Exceptions will be made on a case-by-case basis. Questions about VMs should be e-mailed to USTRANSCOM transcom.scott.tcj9.mbx.pp-rates-intl@mail.mil.
 - e. Movement is normally within a 90-day period however, USTRANSCOM reserves the right to waive the normal 90-day period for VM, if circumstances warrant.
2. When circumstances warrant, USTRANSCOM can adjust the VM End Date by either cancelling, shortening, or lengthening up to 45 days to meet mission requirements.

Item 901 - VM Procedures

1. When the above criteria exist, the responsible PPSO is required to submit a request via DPS to USTRANSCOM providing appropriate information. PPSOs must include:
 - a. POC information (name, telephone number, and e-mail address),

- b. Any special operational requirements in the request, and
- c. The minimum amount of pounds to be handled by each bidding TSP, per day, is normally (USTRANSCOM reserves the right to adjust minimums to meet mission requirements):
 - (1) iHHG: 40,000 lbs.
 - (2) iUB: 10,000 lbs.
2. USTRANSCOM will review the VM request and submit it for bids. DPS will send an e-mail to all eligible TSPs with rates on file for the Channel-COS combination selected and who are eligible (not in an administrative status) to move HHGs throughout the VM (as of the VM solicitation date).
3. TSP will provide containers for block surface movement, including proposed manifest data (i.e., name of vessel, departure, and arrival dates).
4. To participate in the VM,
 - a. TSPs must log into DPS, and
 - b. submit a SFR that is lower than their iHHG/iUB rate on file for the same channel-COS combination.
5. The deadline date for receipt of the rate Tender Number and bid information is specified in the VM solicitation and can be viewed by logging into DPS.
6. TSPs will be required to submit proper and complete information for bids to be considered responsive.
7. PPSOs will provide routing instructions for COS T shipments.
 - a. In the event a shipment is offloaded at a port other than the port designated in block 13, the provisions in Item 1403 of this Tender regarding alternate ports will apply.
 - b. Adjustments to the rate will be authorized, when appropriate, in accordance with established procedures.

Item 902 - Reserved for Future Use

Item 903 - Submission of Rates and Charges

1. The submission of voluntary bids into DPS is the only way to participate in the movement of DoD/USCG sponsored VMs.
 - a. Rates and charges offered in bid submissions must be independently determined and expressed when submitting bids within DPS.
 - b. Each TSP is completely responsible for the proper preparation and submission of its bid(s) in accordance with the procedures prescribed herein.
 - c. E-mailed/faxed submissions will not be accepted.
2. Competitive rate tenders submitted in response to these filing procedures must be submitted by the exact deadline and under the exact terms, conditions, and procedures specified.

3. This solicitation stands alone, and is not influenced by prior practices or procedures, and is subject to modification by USTRANSCOM prior to the solicitation bid deadline or after as needed.
4. TSPs will submit their rates in DPS. For details on VM rate filling see the Volume Move User Guide Transportation Service Provider (TSP) Edition located in the Rates Module under the Volume Move section in DPS.
 - a. TSPs can enter only 1 bid per VM, and rates must be error-free.
 - (1) The TSP may edit, change, correct, or delete any of their entered information during the VM Solicitation bid window.
 - (2) After the VM Bid End Date/Time, no changes, withdrawals, or cancellations are allowed.
 - (3) DPS will prevent rates from being entered after the VM Bid End Date/Time.
 - (4) VMs will not be restricted by the Rate Cycle Dates or Performance Periods.
 - b. The rate
 - (1) will be expressed as a SFR per this Tender.
 - (a) Only 1 SFR is authorized for each VM shipment filed with USTRANSCOM from and to the same origin/destination and COS combination.
 - (b) The SFR(s) entered must be lower than their rate on file for the same channel-COS combination.
 - (2) VM shipments will operate the same as standard shipments except the VM will utilize the VM rates in place of the standard rates on file.
 - (3) Each TSPs VM SFR will apply for each shipment shipped under the VM until its final delivery to the customer.
 - c. In addition to rates and charges, the TSP must enter the following information to be eligible to participate in the VM:
 - (1) The maximum amount of tonnage expressed in pounds per day that can be picked up at origin. The TSP entered maximum amount cannot be below the minimum established by USTRANSCOM.
 - (2) Tender Number.
 - (3) TSP POC information (name, telephone #, and e-mail address).
 - (4) Agreement in DPS to move the minimum daily tonnage required by the VM Solicitation.
 - d. The TSP must agree to the following information to be eligible to participate in the VM process:
 - (1) Move at least the minimum pounds per day identified on the VM Solicitation.
 - (2) Move up to the maximum amount of pounds per day that the TSP identified as being capable of handling. DPS will not offer shipments to a TSP that will exceed the TSPs maximum daily tonnage capability.

- (3) Not refuse any VM shipments.
- e. USTRANSCOM will evaluate all competitive rate offers received from TSPs. Acceptance of rates does not guarantee any offer of shipments or tonnage.
 - (1) Although no guarantee is expressed or implied, USTRANSCOM will make every effort to protect the confidentiality of rates submitted in response to a VM solicitation.
 - (2) VM are processed by the USTRANSCOM PP Special Requirements & Rates Team. Refer any questions to transcom.scott.tcj9.mbx.pp-rates@mail.mil.

Item 904 - Receipt of Submission

1. All bid submissions must be received in DPS on or before the deadline date and time indicated on the solicitation for each VM.
2. USTRANSCOM will not be responsible for rates which are not in DPS prior to the deadline.
3. Computer glitches and other technology issues may occur when submitting bids, therefore TSPs should enter their bid into DPS as soon as possible to meet rate solicitation deadlines.
4. Bids will not be accepted after the VM Bid End Date/Time.
5. If TSPs have issues or discrepancies during the solicitation and bid process it is recommended they contact the DPS helpdesk.

Item 905 - Reserved for Future Use**Item 906 - Terms and Conditions for Individual Rate Bid Submission**

1. TSPs that are in a suspended, non-use, disqualified, or other inactive status during any portion of the VM will not be considered.
2. The rules and regulations contained in the VM procedures provide all terms and conditions and shall not be altered in any manner.
3. These procedures will be retained by the participating TSP.

Item 907 - Effective Period for Accepted Bid Submissions

The Bid Start Date and the Bid End Date will be identified in the initial e-mail sent to all eligible TSPs via DPS. USTRANSCOM reserves the right to adjust the VM Bid End Date/Time or re-solicit bids as determined necessary by USTRANSCOM.

Item 908 - Administrative Action

1. The provisions of this rate solicitation and the Tender of Service apply equally whether moving HHG lots individually or as a VM.
2. Any TSP who willingly submits a rate proposal that misrepresents a material fact shall be grounds for the disqualification of the TSP from future DoD/USCG personal property shipments.
3. If there is lack of appropriate operating authority, such incident shall be subject to referral to the appropriate Government agency for inquiry.
4. TSP performance shall be monitored by both origin and destination JPPSO/PPSO Quality Assurance and subject to administrative actions outlined in DTR Part IV Chapter 405.

5. TSPs whose overall performance clearly indicates an unwillingness to comply with service standards shall be subject to administrative action (Letter of Warning, Letter of Suspension, non-use, etc.).
 - a. Whenever administrative action is issued to a TSP, the resulting action will apply to both regular and VM shipments.
 - b. TSPs understand that transportation offices may give consideration to CSS comments, customer feedback, QA inspection findings, and other performance factors to determine which quality assurance actions are warranted.
 - c. For questions or concerns, please contact USTRANSCOM PP Quality Support Team at transcom.scott.tcj9.mbx.pp-perf@mail.mil.
6. VM shipment refusals are not authorized and are subject to administrative action.
7. Failure to pick up VM shipments or comply with requirements may result in immediate suspension from the VM (to include shipments traveling over the same market not consigned to the VM). If repeated violations occur, suspensions may be progressively escalated as indicated in the DTR 4500.9-R.
8. All VM shipment CSSs are generated and counted towards applicable market (iHHG and iUB) and all existing CSS reports will include CSS data for VM shipments.

Item 909 - Correction to Volume Movement Individual Rate Tenders

1. Corrections or changes to VM rates after the specified Bid End Date will not be permitted.
2. USTRANSCOM will not be responsible for late or misdirected rate bid submissions which do not arrive in DPS prior to the Bid End Date when caused by any party or parties not assigned to USTRANSCOM.
3. USTRANSCOM reserves the right to reject any or all offers, to waive informalities and minor irregularities in offers received, to negotiate, or accept offers without discussion of rates, to non-use any rate, terminate, and/or to re-solicit rates prior to or during the VM effective dates.

Item 910 - Acceptance/Rejection of Individual Rate Submission

1. USTRANSCOM will review each individual rate submission prior to acceptance, rejection, or distribution. TSPs must use the utmost care in bid preparation since rates cannot be withdrawn once the Bid End Date/Time has passed.
2. DPS will notify each TSP via e-mail (to the TSP Master and TSP Operations user roles) with information relative to the acceptance or rejection of its Tender.
 - a. Notification of Acceptance: Inquiries about this solicitation relative to TSP ranking and participation should be satisfied by reference to DPS and viewing the TSPs VM screens.
 - b. Notification of Rejection: Any TSP failing to enter a Tender Number, POC information, or other mandatory information will be stopped by DPS until the information is entered. All TSPs that are rejected will receive a rejection e-mail (to the TSP Master and TSP Operations user roles) indicating the basis for rejection.

Item 911 - Volume Move Rates - Public File

All accepted Tender Numbers are kept via electronic means in DPS.

Item 912 - Selecting Number One TSP for VM

Selection of number one TSP will be selected using the BVS computation matrix. TSPs can view their SCAC's relative ranking by logging into DPS.

Item 913 - Volume Move Shipment Distribution

1. DPS ranks VM TSPs from highest to lowest based on their BVS. The number one ranked TSP is displayed as the "Next TSP To Receive Shipment" and the next lower ranked TSP will be shown as the "Alternate TSP." VM TSPs who have met their maximum daily tonnage requirement will not be displayed and the next two sequentially ranked TSPs will appear as the "Next TSP To Receive Shipment" and "Alternate TSP." This process is system generated and the process repeats daily.
2. PPSOs shall distribute VM shipment tonnage as follows:
 - a. All VM shipments shall be offered to the number one ranked TSP until that TSP has reached the minimum daily tonnage.
 - b. Once the number one ranked TSP reaches the minimum daily tonnage, the PPSOs should continue distributing shipment tonnage to the number 1 TSP until they reach their maximum tonnage; however, PPSOs may award shipments to the alternate TSP.
 - c. When the number one ranked TSP has reached their maximum daily tonnage, the PPSO must distribute the shipment tonnage to the number two ranked TSP for the specified day until they reach the minimum daily tonnage.

Item 914 - Volume Move Blackout Status

1. VM blackouts are identified by VM Start/End Dates, for a given VM or a set of VMs.
 - a. TSPs will be provided the ability to blackout dates for all accepted VM or select dates on a specific accepted VM to blackout.
 - b. TSPs will not be allowed to blackout VM(s) before they are in an accepted status.
2. TSPs in a VM blackout status will be charged the administrative tonnage for any shipment they would have received had they not been blacked out on the TDL (Traffic Distribution List) report.
3. TSPs not in VM blackout status will be subject to USTRANSCOM Personal Property Operational & Quality Support Team administrative action if tonnage minimums are refused.
4. VM blackouts are independent of any other blackout type in the system (e.g., iHHG/iUB blackouts will not blackout a TSP for a VM under which they are accepted).

Item 915 - Additional Guidance

1. When a TSP is offered and accepts a VM shipment and later negotiates a pickup date change outside the VM cycle, the shipment will move under the VM rate and tables that were effective on the original requested pickup date at the time the shipment was offered and accepted by the TSP.
2. DPS shall offer short-fused VM shipments to eligible VM TSPs on a first come, first serve basis.

- a. Short-fuse awards will count towards minimum and maximum daily weight allocations.
 - b. TSPs already reaching their maximum daily weight still receive short-fuse shipment notifications and may accept the shipment if desired.
3. USTRANSCOM reserves the right to authorize manual submissions for VMs requests to support contingency plans in support of the DoD Personal Property mission. Authorized manual VMs will be managed on a case-by-case basis and all guidance will be communicated accordingly between the Origin JPPSO/PPSO and USTRANSCOM PP Special Requirements & Rates Team.
 4. Under this Tender PPSOs reserve the right to process shipments outside the VM using standard channel and current rates on file to meet DoD mission requirements.

Chapter 10 - Special Solicitation

Purpose

This chapter pertains to instructions, information, and procedures on the soliciting and awarding for Special Solicitation (SS) rate areas.

Item 1000 - Standards

1. TSPs submitting rates for each SS group must provide rates for and service all channels that comprise the SS group. Failure to successfully file rates for all channels will negate the TSP the opportunity to be selected the “winner” of the SS group.
2. Rate review:
 - a. TSP rates will be reviewed for consistency with other rates submitted for the same rate area as well as adjacent rate areas.
 - b. Suspect rates will be reviewed by USTRANSCOM on a case-by-case basis.
 - c. TSPs may be required to provide the rate construction breakdown of the suspect rate(s).
 - d. If a rate(s) is deemed to be outside the competitive rate range (e.g., deemed non-compensatory), it will be rejected by DPS.
 - e. The rejection of a single rate will be cause for ineligibility of that TSP for the applicable SS group as they would be unable to service all channels in that SS group.
3. TSPs must submit bids based upon the use of agents/warehouses approved for use by either the DoS or DoD installations responsible for the applicable overseas area.
 - a. TSPs are responsible for validating the selected DoD/DoS warehouse(s) is/are approved in DPS prior to filing rates.
 - b. The name and point of contact of your agent in overseas areas must be submitted by the deadline dates established by USTRANSCOM for all SS groups accepted.
 - (1) Failure to select and report an approved DoD/DoS Agent will cause your Tender to be non-responsive and lead to removal from that SS group by USTRANSCOM.
 - (2) Accepted TSPs may change their agents as long as the selected agent is DoD/DoS approved and the TSPs SFR does not change.
 - c. USTRANSCOM reserves the right to change and update the known agent listing based on DoD/DoS inputs within the specific rate cycle.
 - (1) In the event DoD/DoS places a known agent in non-use status, TSPs using that agent will be afforded 45 days to negotiate and acquire a DoD/DoS approved replacement agent as stated above.
 - (2) During that timeframe the TSP will not be ranked for bookings and PPSOs will use the #2 TSP who will act as the #1 TSP.
 - (3) Failure to meet the 45 days replacement agent timeline will be grounds for removal from the affected SS group for the remainder of the peak/nonpeak period and/or annual cycle.

- (4) Agents requesting approval should address their request to the DoD/DoS representative.

Item 1001 - Estimated Traffic/Shipments

1. Estimated traffic/shipments are based on historical records.
2. Traffic/shipment data will not be construed as a guarantee by the Government of any volume of traffic.

Item 1002 - Reserved for Future Use

Item 1003 - General

1. These procedures solicit competitive rates for the below SS areas.
2. All shipments will be controlled by various PPSOs dependent upon the customer's duty station.
3. Each channel-COS combination below comprises one unique SS group. Specific channel groupings that comprise each SS are located at <https://www.ustranscom.mil/dp3/pdfs.cfm>.
4. Class 1 SS Groupings:
 - a. COS 8 shipments to/from **Australia** (AS11) and CONUS rate areas.
 - b. COS 8 shipments to/from **Australia** (AS21) and CONUS rate areas.
 - c. COS J/T shipments to/from **Azores** (PO01) and CONUS rate areas.
 - d. COS 8 shipments to/from **Bahrain** (BA) and CONUS rate areas.
 - e. COS 8 shipments to/from **Belgium** (BE) and CONUS rate areas.
 - f. COS 8/J shipments to/from **Guam** (GQ) and CONUS rate areas.
 - g. COS 8 shipments to/from **Israel** (IS) and CONUS rate areas.
 - (1) TSPs filing COS 8 SS rates to IS will include destination agent service charges in their SFR.
 - (2) TSPs filing COS 8 SS rates from IS will include origin agent service charges in their SFR.
 - h. COS J shipments to/from **Japan-South** (JA02) and CONUS rate areas.
 - i. COS 8/J shipments to/from **Japan-North** (JA03) and CONUS rate areas.
 - j. COS 4/8 shipments to/from **Jordan** (JO) and CONUS rate areas.
 - k. COS 4/8 shipments to/from **Kuwait** (KU) and CONUS rate areas.
 - l. COS 8/J shipments to/from **Netherlands** (NL) and CONUS rate areas.
 - m. COS 4/8 shipments to/from **Norway** (NO) and CONUS rate areas.
 - n. COS 4/8 shipments to/from **Poland** (PL) and CONUS rate areas.
 - o. COS 8 shipments to/from **Portugal** (PO) and CONUS rate areas.
 - p. COS 8 shipments to/from **Puerto Rico** (RQ) and CONUS rate areas.

- q. COS 6/8 shipments to/from **Qatar** (QA) and CONUS rate areas.
 - r. COS 8 shipments to/from **Romania** (RO) and CONUS rate areas.
 - s. COS 6/8 shipments to/from **Saudi Arabia** (SA) and CONUS rate areas.
 - (1) Shipments assigned to U.S. Military Training Mission (USMTM) controlled AOR within Saudi Arabia will be serviced by HQ USMTM, PPSO, Riyadh. Please refer to the PPCIG for contact information.
 - (2) TSPs filing COS 6/8 SS rates to SA will include destination agent service charges in their SFR.
 - (3) TSPs filing COS 6/8 SS rates from SA will include origin agent service charges in their SFR.
 - t. COS 4/8 shipments to/from **Singapore** (SN) and CONUS rate areas.
 - u. COS 4/8/T shipments to/from **South and Central American** countries and CONUS rate areas.
 - (1) Due to the use of commercial narrow-body aircraft, external shipping containers for Code T shipments moving to/from South and Central America in accordance with PPP-B-601, style A or B, are required, not to exceed 60 inches in height.
 - (2) In accordance with Item 508, special packing arrangements will be authorized by the PPSO for oversize items which will not fit into the restricted height container.
 - (3) TSPs will submit bids based upon the use of DoD/DoS approved agents.
 - (4) CONUS AMC terminal - Charleston
 - v. COS 4/8/J/T shipments to/from **Turkey** (TU) and CONUS rate areas.
 - w. COS 8 shipments to/from **United Kingdom** (UK) and CONUS rate areas.
5. Class 2 SS Groupings:
- a. COS J shipments to/from **Germany** (GE) and CONUS rate areas.
 - b. COS J shipments to/from **Hawaii** (US89) and CONUS rate areas.
 - c. COS J shipments to/from **Japan-Central** (JA01) and CONUS rate areas.
 - d. COS J shipments to/from **Japan-Okinawa** (JA96) and CONUS rate areas.
 - e. COS J shipments to/from **Korea** (KS) and CONUS rate areas.
 - f. COS J shipments to/from **United Kingdom** (UK) and CONUS rate areas.

Note: For Class 2 SS Groupings, weight verification on shipments performed at the port agent's facility may be used for a reweigh requirement for SS UB, unless the PPSO requests a reweigh on a shipment before delivery to customer. If the requested reweigh is performed, the TSP must meet the threshold requirement to seek payment for the requested reweigh as listed under Item 505, Reweigh (UB).

Item 1004 - Participation and Performance

1. Participation in these RFQs is strictly voluntary.

2. Each Class 1 and Class 2 SS grouping is a winner takes all based on the TSP with the highest overall BVS for the aggregate of all channels in the special solicitation.
3. For Class 1 SS Groups, TSPs may not blackout or refuse shipments on any channels that comprise the SS group once selected as the primary (winner).
4. For Class 2 SS Groups, TSPs may not blackout but may refuse shipments on channels that comprise the SS group once their capacity is exhausted, and PPSOs may select from the lower ranked BVS TSPs in those cases. Selective refusals or permanent loss of capacity in one or more channels that comprise the SS Group may result in the next highest ranked TSP being named the primary (winner) for the duration of the peak or non-peak period.
5. TSPs participating in the SS program are subject to administrative actions IAW DTR Ch. 402 & Ch. 405.
6. For Class 1 and 2 groupings, if the primary TSP (winner) is suspended or placed in non-use, the corresponding sequential TSP (i.e., #2, #3, #4, etc.) will become the primary (winner) TSP for all specific (Market, GBLOC, Channel) SS shipments until suspended or non-use TSP is reinstated, or the rate cycle ends.
7. USTRANSCOM may remove TSPs failing to meet service standards.

Item 1005 - State Department Agents for OCONUS SS Rate Areas

1. TSPs are encouraged to contact the local Embassy representative for assistance.
2. TSPs are responsible for maintaining communication with all authorized agents to ensure compliance with Item 1000 of this chapter.
3. Please refer to Chapter 12 of this Tender for all DoS Arranged Moves to, from, and between DoS locations.

Chapter 11 - Code J Unaccompanied Baggage

Purpose

This chapter contains information on the movement of Code J shipments.

Item 1100 - Reserved for Future Use

Item 1101 - Terms and Conditions

1. These terms and conditions apply specifically to the handling and management of shipments moving between overseas areas and CONUS.
2. TSPs participating agree to:
 - a. Comply with requirements and procedures of AMC in reporting, documenting, and handling military shipments. This includes
 - (1) palletizing shipments,
 - (2) preparation of the TCMD (DD Form 1384), for each pallet or individual shipment, and place a copy of the TCMD in a waterproof pouch on the number one container of the shipment.
 - (3) preparing and attaching the DD Form 1387 (Military Shipping Label),
 - (4) delivery of pallet loads or individual shipments to the AMC air terminal, and
 - (5) the receipt of pallet loads or individual shipments from AMC air terminal, from a Theater Shipping and Consolidation Point entity, or conveyance.
 - b. Accept 100 percent of the traffic tendered.
 - c. Assume on a door-to-door basis, full responsibility for shipments and liability to the limits prescribed in the Claims Liability Business Rules.
 - d. Pick up cargo from AMC no later than one GBD from time of notification or to take receipt of cargo from a Theater Shipping and Consolidation Point entity/conveyance no later than one GBD from time of notification and forward these shipments to their ultimate destination.

Item 1102 - 1104 Reserved for Future Use

Item 1105 - Movement from CONUS to Overseas

1. CONUS port agent must ensure outbound shipments are not delayed at their facilities.
2. Weight Tolerance:
 - a. Port agents must ensure that total gross weight of all shipments on pallets identified in record position (RP) 72-76 of the pallet header matches the gross weights of individual shipments identified in RP 72-76 of the prime data for each shipment.
 - b. In the event the aerial port weighs the pallet, and the tare weight of the pallet is plus or minus 150 lbs. of the original weight indicated in RP 72-76 of the prime data,
 - (1) the pallet is considered out of tolerance and

- (2) will be turned back to the TSP or port agent to resolve the difference in weights.
- (3) TSPs will have to break down the pallet and weigh each piece or correct their documentation.

Item 1106 - Movement from Overseas to CONUS

1. Overseas port agent's responsibilities:
 - a. Ensuring outbound shipments are not delayed at their facilities.
 - b. Shipments with 20 days or less to the RDD will be delivered to the AMC terminal within 72 hours after arriving at the port agent's facility.
 - c. Shipments with over 21 days to the RDD will be held for consolidation. However, when the aerial port and port agents agree there are not sufficient tonnage/shipments being generated to build pallet loads, shipments will be delivered to the AMC air terminal within 72 hours after arriving at the port agent's facility.
2. TSPs must ensure their designated agents/port agents maintain vehicle and container conditions and protection IAW DTR Part IV, Appendix B.
 - a. TCMDs:
 - (1) Port agents are responsible for preparing a TCMD for each pallet load or individual shipment delivered to the AMC terminal.
 - (2) TSPs are responsible for ensuring their port agents have the necessary equipment for preparing TCMDs.

Item 1107 - Tracing Procedures

1. TSPs will trace a shipment on request from a PPSO and make a report as to its location within 72 hours.
2. When a tracer is received on a shipment that has entered the AMC airlift system the following procedures will apply:
 - a. Confirm with your port agent the shipment has been delivered to the AMC aerial port.
 - b. Once this has been determined, contact the applicable air clearance authority (ACA) for lift data. Ensure you are tracing with the correct TCN.
 - c. Provide the tracing activity with,
 - (1) the name of the APOE,
 - (2) the date you delivered the shipment to the APOE, and
 - (3) all known lift data.
 - d. Advise the tracing activity if the ACA has not been able to provide lift data.

Chapter 12 - Department of State Arranged Moves

Purpose

DoD and USCG Personnel assigned official duty to a diplomatic assignment under Chief of Missions and classified as permanent personnel or temporary duty personnel for more than 90 days, are authorized shipment of HHGs/TDY weight allowance using DoS transportation services IAW DTR, Part IV, Appendix F, and applicable PPCIG Country Instructions.

Item 1200 - Participation

Questions regarding whether or not a shipment is eligible to be moved via DoS should be referred to the DoS Transportation & Travel Management Division:

U.S. Department of State

Transportation & Travel
Management Division Phone: (800) 424-2947 or (202) 663-0891 / 0892
Fax: (202) 663-3209
e-mail: DoDPP@state.gov

Item 1201 - Procedures

1. For DoS shipments, DoD and USCG PPSOs shall follow these instructions:
 - a. Ensure customers are counseled within the DPS IAW JTR entitlements and service regulations. Counseling must be documented using DD Form 1797.
 - b. Ensure DD Form 1299 is accomplished for each shipment and contains the following statement in the remarks block "Department of State Managed Shipment."
 - c. Submit DD Form 1299, DD Form 1797, and a copy of the customer's orders via fax/e-mail to U.S. Department of State Transportation and Travel Management Division, Phone 1-800-424-2947 OR 202-663- 0891/0892, Fax: (202) 663-3209, e-mail: DoDPP@state.gov.
 - d. After submission of required documents to DoS, place the DPS shipment record in a cancelled status.
2. PPSO must advise the customer to coordinate pickup and delivery directly with DoS transportation.
3. For specific questions regarding this chapter, please utilize the following USTRANSCOM PP organizational e-mail addresses:
 - a. USTRANSCOM J9 PP Special Requirements & Rates Team:
Special Solicitation: transcom.scott.tcj9.mbx.pp-rates-intl@mail.mil
One-Time-Only: transcom.scott.tcj9.mbx.pp-rates-oto@mail.mil
 - b. USTRANSCOM J9 Europe:
Special Solicitation/One-Time-Only: usarmy.sembach.598-trans-bde.mbx.ppd@mail.mil
 - c. USTRANSCOM J9 Pacific:
Special Solicitation/One-Time-Only: usarmy.wheeler.sddc.mbx.sddc-pac-pp@mail.mil

- d. USTRANSCOM J9 PP Operational & Quality Support Team: transcom.scott.tcj9.mbx.pp-ops@mail.mil

Chapter 13 - Rate Areas and Maps

Purpose

1. This chapter contains rate area maps and/or explanations which illustrate special rate Tender information and/or the subdivision of states and countries.
2. All other rate areas encompass the entire state or country.

Item 1300 - Reserved for Future Use

Item 1301 - Special Rate Information - CONUS

1. The following states are subdivided into more than one rate area. Maps showing the specific rate area for each PPSO in that state can be found in Item 1303.
 - a. California:
 - (1) US87 (North)
 - (2) US88 (South)
 - b. Florida:
 - (1) US49 (North)
 - (2) US4964400 (South)
 - (3) US4965500 (Keys)
 - c. Texas:
 - (1) US66 (North)
 - (2) US68 (South)
2. Guidance for the District of Columbia (US24).
 - a. Covers only that area designated as the city limits of Washington, DC.
 - b. The counties and municipalities in Maryland and Virginia, formerly included in US24 DC, are not considered part of US24.
 - c. The metropolitan area associated with local drayage will not be recognized as the boundary of DC for movement of personal property in the international program.

Item 1302 - Special Rate Information - OCONUS

1. The following countries/areas are either split into multiple rate areas or have unique requirements identified below:
 - a. Alaska
 - (1) UB rates (Codes 7 and 8) are the only codes of service solicited under the international program between CONUS and Alaska.
 - (2) Rates will be solicited for shipments moving to/from (see map in Item 1303 to identify Zone coverage).
 - (a) US8101000 (Zone I)
 - (b) US8190100 (Zone II)

-
- (c) US8050500 (Zone III)
 - (d) US8030400 (Zone V) - (Except cities identified under Zone IV, which will be handled under the OTO program).
 - (3) US8142800 (Zone IV) - OTO Area
 - b. Australia
 - (1) Rates will be solicited for shipments moving to/from (see map in Item 1303)
 - (a) the Australian Capital Territory (ACT) (AS11),
 - (b) New South Wales (AS11), and
 - (c) Alice Springs (AS21).
 - (2) All other areas (AS71) will be handled under the OTO program.
 - c. Brazil
 - (1) Shipments to/from Rio de Janeiro (BR10) will be handled under the OTO program.
 - d. Canada
 - (1) Rates will be solicited for shipments moving to/from (see map in Item 1303).
 - (a) CA10 (Ontario),
 - (b) CA20 (Quebec), and
 - (c) CA30 (Manitoba).
 - (2) All other areas (CA) will be handled under the OTO program.
 - e. Germany
 - (1) Rates will be solicited for Germany (GE).
 - (2) Shipments to/from the former Deutsche Demokratische Republik (DDR) (GE01) will be processed under the OTO program. These areas include:
 - (a) Berlin,
 - (b) Leipzig,
 - (c) Dresden,
 - (d) Rostock, and
 - (e) Neukirch.
 - f. Greece
 - (1) Rates will be solicited for the Island of Crete (GR29).
 - (2) Shipments to/from Greece (GR) will be handled under the OTO program.
 - g. Hawaii
 - (1) Rates will be solicited for shipments moving to/from US89 (Island of Oahu).
 - (2) Shipments to/from all neighbor islands of Oahu (US891) will be handled under the OTO program.

h. Italy

(1) Rates will be solicited for shipments moving to/from

(a) Italy (IT)

(b) Sicily (IT10)

(2) Shipments to/from Sardinia (IT20) will be handled under the OTO program.

i. Japan

(1) Rates will be solicited for shipments moving to/from (see map in Item 1303).

(a) JA01 (Central): Consists of

1 All prefectures in central Japan north of Hyogo Prefecture to Yamagata, and Miyagi prefectures (but not including Yamagata, and Miyagi prefectures).

2 Including but not limited to:

3 Yokota AB

4 Camp Zama

5 NAF Atsugi

6 CFAY Yokosuka

(b) JA02 (South): Consists of all prefectures in southern Japan commencing with Hyogo prefecture.

The installations of:

1 Sasebo NB and

2 MCAS Iwakuni.

(c) JA03 (North): Consists of

All prefectures in northern Japan

1 Island of Yamagata and

2 Miyagi prefectures

3 The installation of Misawa AB.

(d) JA96 (Okinawa): Consists of all shipments to/from Okinawa.

1 USAG Makiminato,

2 Kadena AB (including US Fleet Activity, Kadena),

3 MCB Camp Butler, and

4 US Fleet Activity, Kadena.

(e) JA04 (Hokkaido): Shipments to/from the island of Hokkaido will be handled under the OTO program.

j. Korea

(1) Rates will be solicited for shipments moving to/from Korea (KS).

(2) Shipment to/from the outer island of Cheju-do (KS01) will be handled under the OTO program.

k. Puerto Rico

(1) Rates will be solicited for shipments moving to/from Puerto Rico (RQ)

(2) Shipments to/from the offshore communities of Vieques and Culebra (RQ01) will be handled under the OTO program.

l. Spain

(1) Rates will be solicited for shipments moving to/from Spain (SP).

(2) Shipments to/from the below locations (SP01) will be handled under the OTO program:

(a) Estaca De Vares, El Ferrol Del Caudillo,

(b) Estartit, and

(c) Part of the Balearic Islands

1 Menorca

2 Mallorca

3 Formentera

4 Ibiza

m. United Kingdom

(1) The United Kingdom consists of 4 separate countries: England, Scotland, Wales, and Northern Ireland broken into 3 distinct rate areas.

(a) Rates will be solicited for shipments moving to/from England and Wales (UK).

(b) Scotland (UK76) and Northern Ireland (EI) will be handled under the OTO program.

Item 1303 - Maps of States and Countries Divided into Separate Rate Areas

California

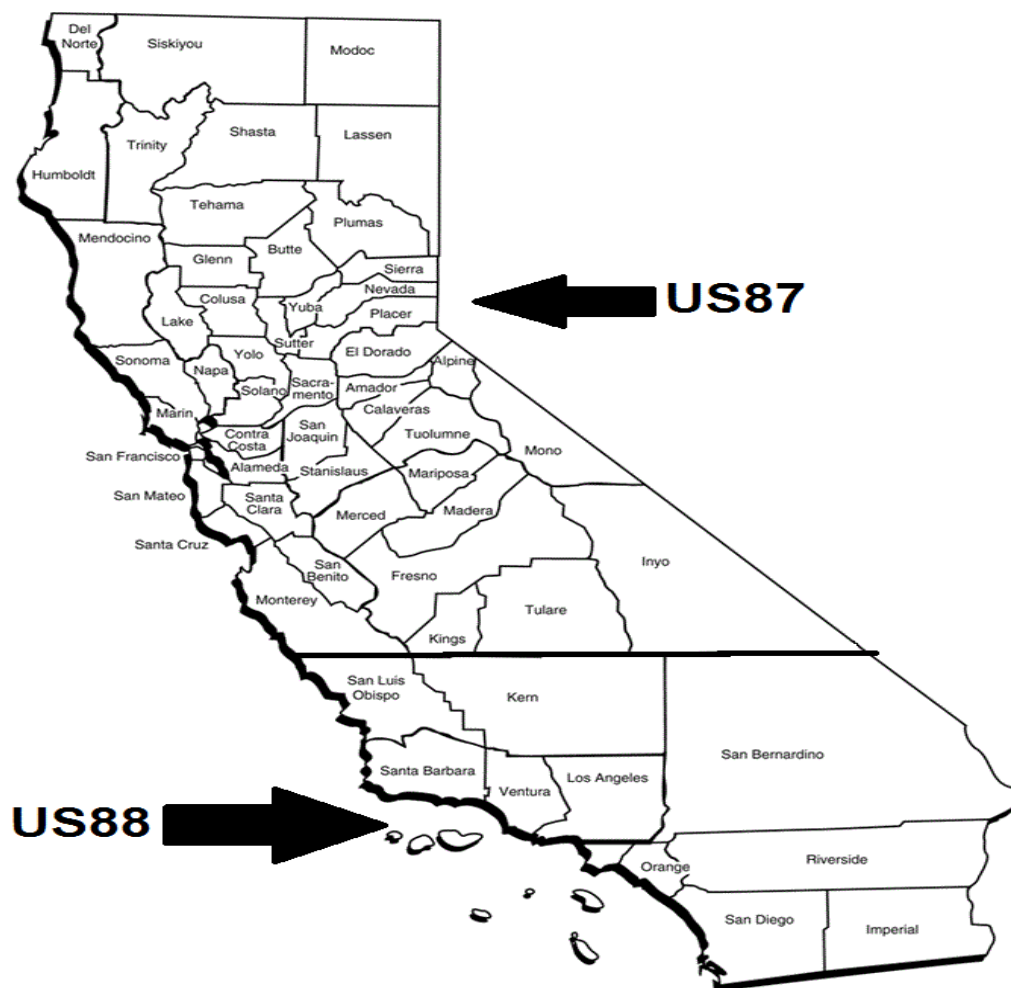

US87 - North

- *JPPSO-NC (KKFA)
- COGUARD Alameda (LHNQ)
- JPPSO-SW (LKNQ)

US88 - South

- JPPSO-SW (LKNQ)
- *JPPSO-NC (KKFA)

*PPSOs located in adjacent states controlling traffic in the rate areas indicated

Florida

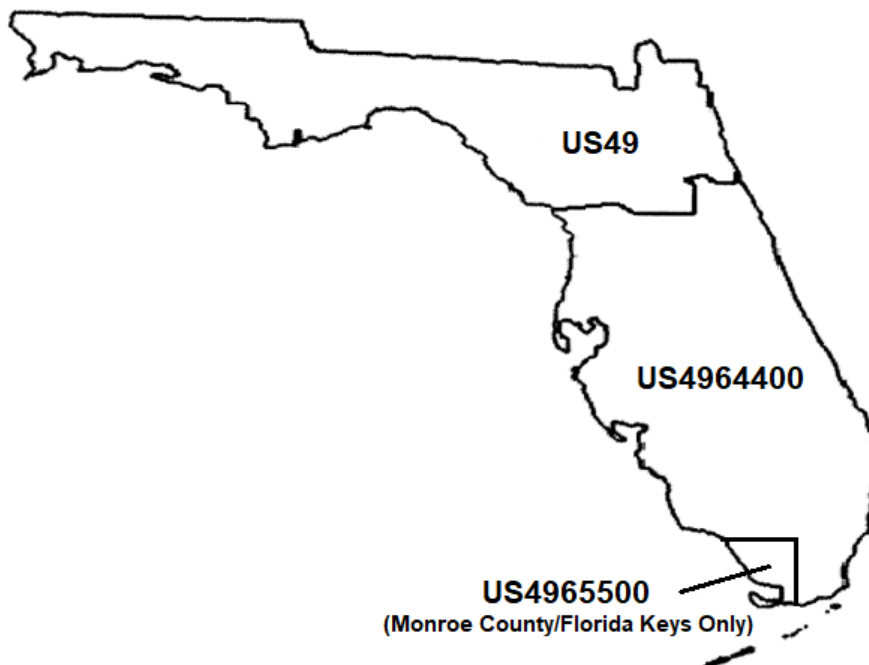

US49 – North

- *JPPSO-SC (HAFC)
- JPPSO-SE (CNNQ)

US4964400 – South

- *JPPSO-SC (HAFC)
- JPPSO-SE (CNNQ)
- 7th CG District, Miami (CLPK)

US4965500 – Keys

- JPPSO-SE (CQNL)

*PPSOs located in adjacent states controlling traffic in the rate areas indicated.

Florida: US49, US4964400 and US4965500 Counties

US49		
Alachua	Gadsden	Marion
Baker	Gilchrist	Nassau
Bay	Gulf	Okaloosa
Bradford	Hamilton	Putnam
Calhoun	Holmes	Santa Rosa
Clay	Jackson	St Johns
Columbia	Jefferson	Suwannee
Dixie	Lafayette	Taylor
Duval	Leon	Union
Escambia	Levy	Wakulla
Flagler	Liberty	Walton
Franklin	Madison	Washington

US4964400		
Brevard	Indian River	Polk
Broward	Lake	Sarasota
Charlotte	Lee	Seminole
Citrus	Manatee	St Lucie
Collier	Martin	Sumter
Desoto	Miami-Dade	Volusia
Glades	Okeechobee	
Hardee	Orange	
Hendry	Osceola	
Hernando	Palm Beach	
Highlands	Pasco	
Hillsborough	Pinellas	

US4965500		
Monroe		

Texas

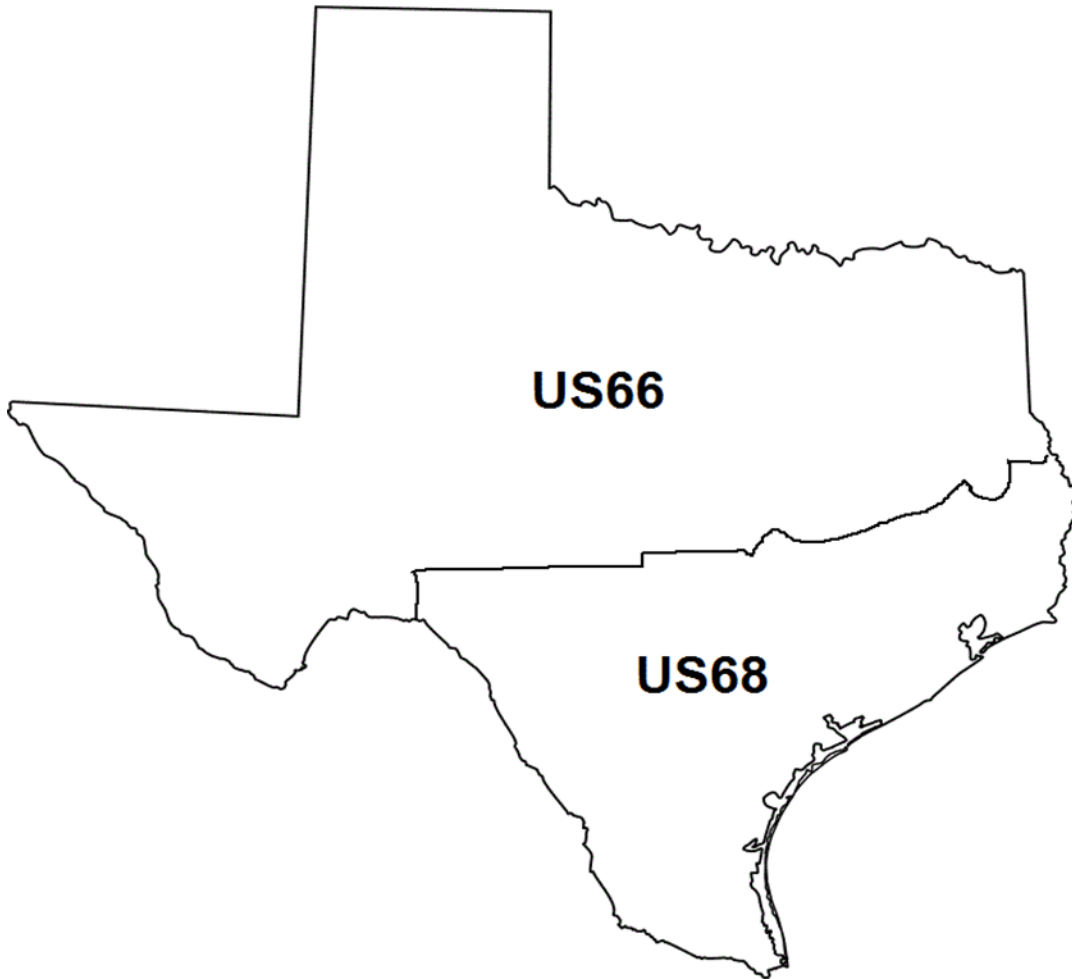

US66 - North

- Ft. Cavazos (HBAT)
- JPPSO-SC (HAFC)
- *JPPSO-NC (KKFA)

US68 - South

- JPPSO-SC (HAFC)
- JPPSO-SE (CNNQ)

*PPSOs located in adjacent states controlling traffic in the rate area indicated.

Texas: Counties

US66 - North			
Anderson	Dickens	Jones	Red River
Andrews	Donley	Kaufman	Reeves
Archer	Eastland	Kent	Roberts
Armstrong	Ector	Kimble	Rockwall
Bailey	El Paso	King	Runnels
Baylor	Ellis	Knox	Rusk
Bell	Erath	Lamar	San Saba
Borden	Falls	Lamb	Schleicher
Bosque	Fannin	Lampasas	Scurry
Bowie	Fisher	Limestone	Shackelford
Brewster	Floyd	Lipscomb	Sherman
Briscoe	Foard	Llano	Smith
Brown	Franklin	Loving	Somervell
Burnet	Freestone	Lubbock	Stephens
Callahan	Gaines	Lynn	Sterling
Camp	Garza	Montague	Stonewall
Carson	Glasscock	Marion	Sutton
Cass	Gray	Martin	Swisher
Castro	Grayson	Mason	Tarrant
Cherokee	Gregg	McCulloch	Taylor
Childress	Hale	McLennan	Terrell
Clay	Hall	Menard	Terry
Cochran	Hamilton	Midland	Throckmorton
Coke	Hansford	Mills	Titus
Coleman	Hardeman	Mitchell	Tom Green
Collin	Harrison	Moore	Upshur
Collingsworth	Hartley	Morris	Upton
Comanche	Haskell	Motley	Van Zandt
Concho	Henderson	Navarro	Ward
Cooke	Hemphill	Nolan	Wheeler
Coryell	Hill	Ochiltree	Wichita
Cottle	Hockley	Oldham	Wilbarger
Crane	Hood	Palo Pinto	Winkler
Crockett	Hopkins	Panola	Wise
Crosby	Howard	Parker	Wood
Culberson	Hudspeth	Parmer	Yoakum
Dallam	Hunt	Pecos	Young
Dallas	Hutchinson	Potter	
Dawson	Irion	Presidio	
Deaf Smith	Jack	Rains	
Delta	Jeff Davis	Randall	
Denton	Johnson	Reagan	

US68 - South		
Angelina	Karnes	Webb
Aransas	Kendall	Wharton
Atascosa	Kenedy	Willacy
Austin	Kerr	Williamson
Bandera	Kinney	Wilson
Bastrop	Kleberg	Zapata
Bee	La Salle	Zavala
Bexar	Lavaca	
Blanco	Lee	
Brazoria	Leon	
Brazos	Liberty	
Brooks	Live Oak	
Burleson	Madison	
Caldwell	Matagorda	
Calhoun	Maverick	
Cameron	McMullen	
Chambers	Medina	
Colorado	Milam	
Comal	Montgomery	
DeWitt	Nacogdoches	
Dimmit	Newton	
Duval	Nueces	
Edwards	Orange	
Fayette	Polk	
Fort Bend	Real	
Frio	Refugio	
Galveston	Robertson	
Gillespie	Sabine	
Goliad	San Augustine	
Gonzales	San Jacinto	
Grimes	San Patricio	
Guadalupe	Shelby	
Hardin	Starr	
Harris	Travis	
Hays	Trinity	
Hidalgo	Tyler	
Houston	Uvalde	
Jackson	Val Verde	
Jasper	Victoria	
Jefferson	Walker	
Jim Hogg	Waller	
Jim Wells	Washington	

Alaska

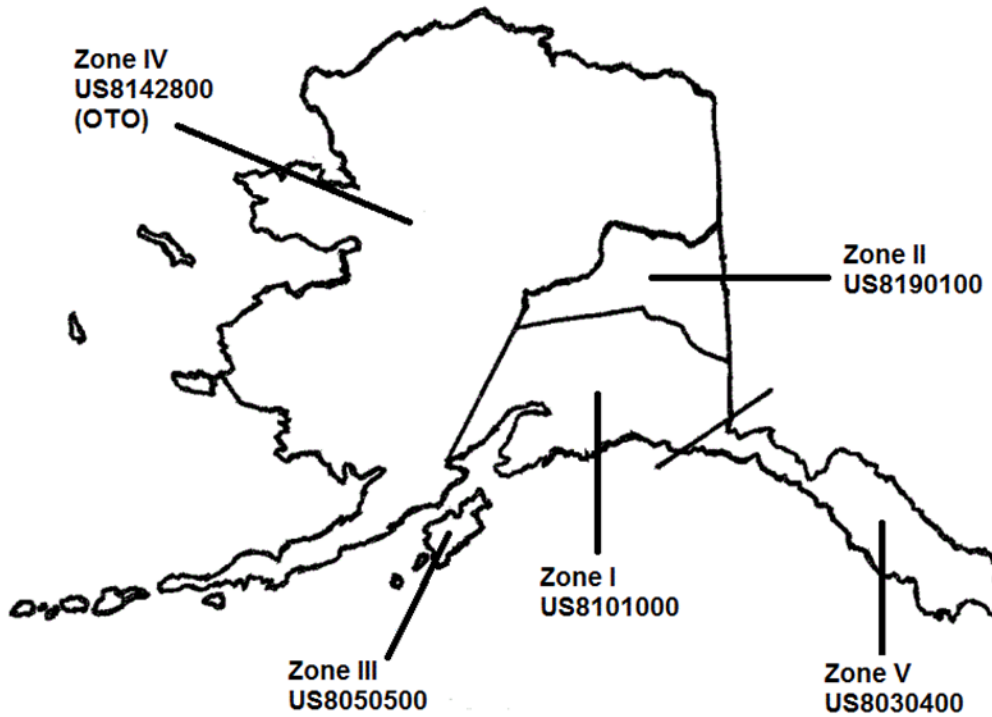

Rate Area	ZONE	INSTALLATION/LOCATION
US8101000	Zone I	JB Elmendorf-Richardson (MBFL)
US8190100	Zone II	JB Elmendorf-Richardson (MBFL) Eielson AFB (MBFL) Clear Space Force Station (MBFL) JB Lewis McChord (JEAT) Fort Wainwright (JEAT-All Services except Air Force) (MBFL-Air Force) Fort Greely (JEAT)
US8050500	Zone III	USCG Kodiak (MAPS)
US8142800	Zone IV	(OTO AREA) Cordova only (MAPS) JB Elmendorf-Richardson (MBFL)
US8030400	Zone V	USCG Ketchikan, Juneau, Sitka, Petersburg, Auke Bay, Douglas, Ward Cove, Wrangell (MAPK)

*Please refer to each GBLOC in the PPCIG for further information

Alaska: Cities

Zone I US8101000	Zone II US8190100	Zone III US8050500	Zone V US8030400
Anchor Point	Anderson	Chiniak	Auke Bay
Anchorage	Badger	Kodiak	Douglas
Big lake	Cantwell		Juneau
Chickaloon	Chicken		Ketchikan
Chitina	Clear Space Force Station		Petersburg
Chugiak	Coldfoot		Sitka
Clam Gulch	Delta Junction		Ward Cove
Cooper Landing	Denali National Park		Wrangell
Copper Center	Dot lake		
Eagle River	Eagle		
Elmendorf AFB	Eielson AFB		
Fort Richardson	Ester		
Fritz Creek	Fairbanks		
Gakona	Fort Greely		
Girdwood	Fort Wainwright		
Glennallen	Healy		
Homer	Manley Hot Springs		
Hope	Mentasta Lake		
Houston	Nenana		
Indian	North Pole		
Kasilof	Northway		
Kenai	Salcha		
Miers Lake	Steese		
Moose Pass	Tok		
Nikiski	Two Rivers		
Nikolaevsk			
Ninilchik			
Palmer			
Seldovia			
Seward			
Slana			
Soldotna			
Sterling			
Sutton			
Talkeetna			
Trapper Creek			
Valdez			
Wasilla			
Whittier			
Willow			

Alaska: Cities (Zone IV - OTO US8142800)

Adak	Craig *	Kasaan *	Newtok	Sand Point
Akhiok	Crooked Creek	Kasigluk	Nightmute	Savoonga
Akiachak	Deering	Kiana	Nikolai	Scammon Bay
Akiak	Dillingham	King Cove	Nikolski	Selawik
Akutan	Diomede	King Salmon	Noatak	Shageluk
Alakanuk	Dutch Harbor	Kipnuk	Nome	Shaktolik
Aleknagik	Edna Bay *	Kivalina	Nondalton	Shishmaref
Allakaket	Eek	Klawock *	Noorvik	Shungnak
Ambler	Egegik	Kobuk	Nuiqsut	Skagway *
Anaktuvuk	Ekwok	Kokhanok	Nulato	Skwentna
Anaktuvuk Pass	Elfin Cove *	Koliganek	Nunam Iqua	Sleetmute
Angoon *	Elim	Kongiganak	Nunapitchuk	South Naknek
Aniak	Emmonak	Kotlik	Old Harbor	Stebbins
Anvik	English Bay	Kotzebue	Ouzinkie	Stevens Village
Arctic Village	False Pass	Koyuk	Pedro Bay	Stony River
Atka	Fort Yukon	Koyukuk	Pelican *	Takotna
Atmautluak	Galena	Kwethluk	Perryville	Tanacross
Atqasuk	Gambell	Kwigillingok	Pilot Point	Tanana
Barrow	Golovin	Lake Minchumina	Pilot Station	Tatitlek
Beaver	Goodnews Bay	Larsen Bay	Platinum	Teller
Bethel	Grayling	Levelock	Point Baker *	Tenakee Springs *
Bettles Field	Gustavus *	Little Diomede	Point Hope	Thorne Bay *
Brevig Mission	Haines *	Lower Kalskag	Point Lay	Togiak
Buckland	Halibut Cove	Manokotak	Port Alexander *	Toksook Bay
Central	Holy Cross	Marshall	Port Alsworth	Tuluksak
Chalkyitsik	Hoonah *	McGrath	Port Graham	Tuntutuliak
Chefornak	Hooper Bay	Mekoryuk	Port Heiden	Tununak
Chenega Bay	Hughes	Metlakatla *	Port Lions	Twin Hills
Chevak	Huslia	Meyers Chuck *	Prudhoe bay	Tyonek
Chignik	Hydaburg *	Minto	Quinhagak	Unalakleet
Chignik Lagoon	Hyder *	Mountain Village	Rampart	Unalaska
Chignik Lake	Igiugig	Naknek	Red devil	Venetie
Chuathbaluk	Iliamna	Nanwalek	Ruby	Wainwright
Circle	Kake *	Napakiak	Russian Mission	Wales
Clarks Point	Kaktovik	Napaskiak	Saint George	White Mountain
Coffman Cove *	Kalskag	Naukati Bay *	Saint Mary's	Yakutat *
Cold Bay	Kaltag	Nelson Lagoon	Saint Michael	
Cordova * (MAPS)	Karluk	New Stuyahok	Saint Paul	

*Cities geographically located in Zone V

Australia

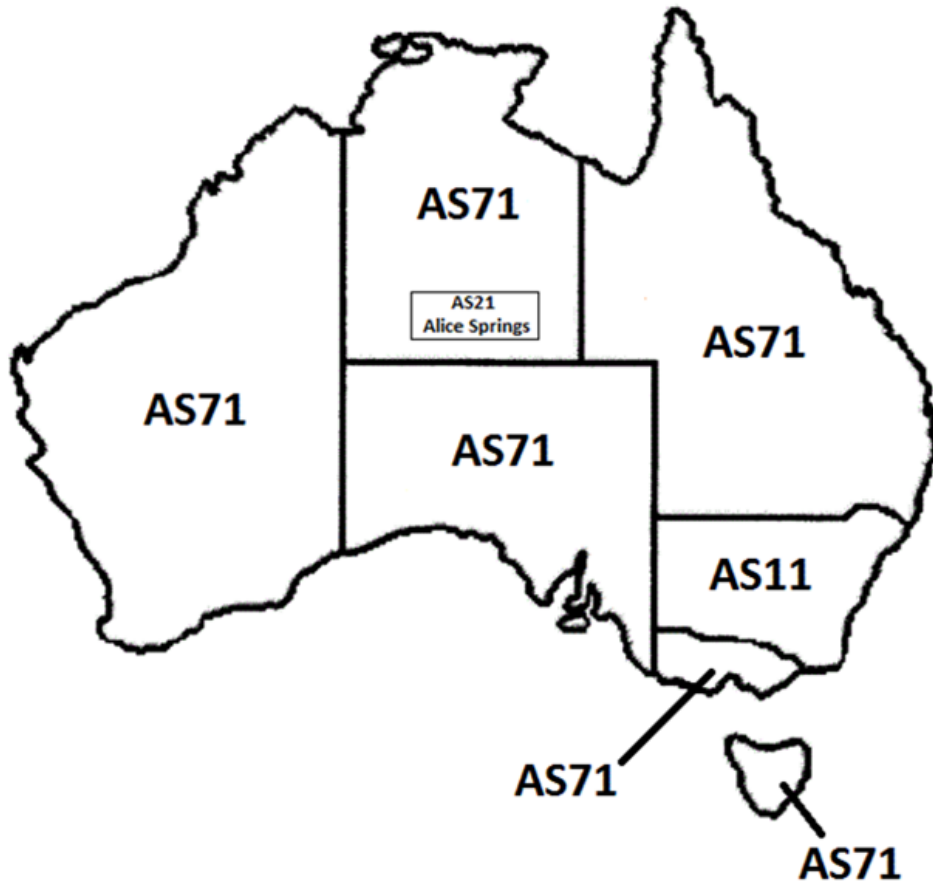

- AS11**
 - Australian Capital Territory (ACT)
 - New South Wales
- AS21**
 - Alice Springs
- AS71**
 - All Other Areas (OTO)

Note: Please refer to the PPCIG Country Instructions or additional guidance.

Canada



CA10 (Ontario)		CA20 (Quebec)	CA30 (Manitoba)
Brant	Middlesex	Abitibi-Témiscamingue	Central Plains
Bruce	Muskoka	Capitale-Nationale	Eastman
Chatham-Kent	Niagara	Centre-du-Québec	Interlake
Dufferin	Nipissing	Chaudière-Appalaches	Pembina Valley
Durham	Northumberland	Estrie	Westman
Elgin	Ottawa	Lanaudière	Winnipeg Capital Region
Essex	Oxford	Laurentides	
Frontenac	Parry Sound	Laval	
Grey	Peel	Mauricie	
Haldimand-Norfolk	Perth	Montréal	
Haliburton	Peterborough	Outaouais	
Halton	Prescott and Russell		
Hamilton	Prince Edward		
Hastings	Renfrew		
Huron	Simcoe		
Kawartha Lakes	Stormont, Dundas and Glengary		
Lambton	Toronto		
Lanark	Waterloo		
Leeds & Grenville	Wellington		
Lennox & Addington	York		

Note:

CA (OTO) All unshaded areas are OTOs
 CA10 (Ontario) listed in Census Divisions
 CA20 (Quebec) listed in Regions
 CA30 (Manitoba) listed in Regions

Japan

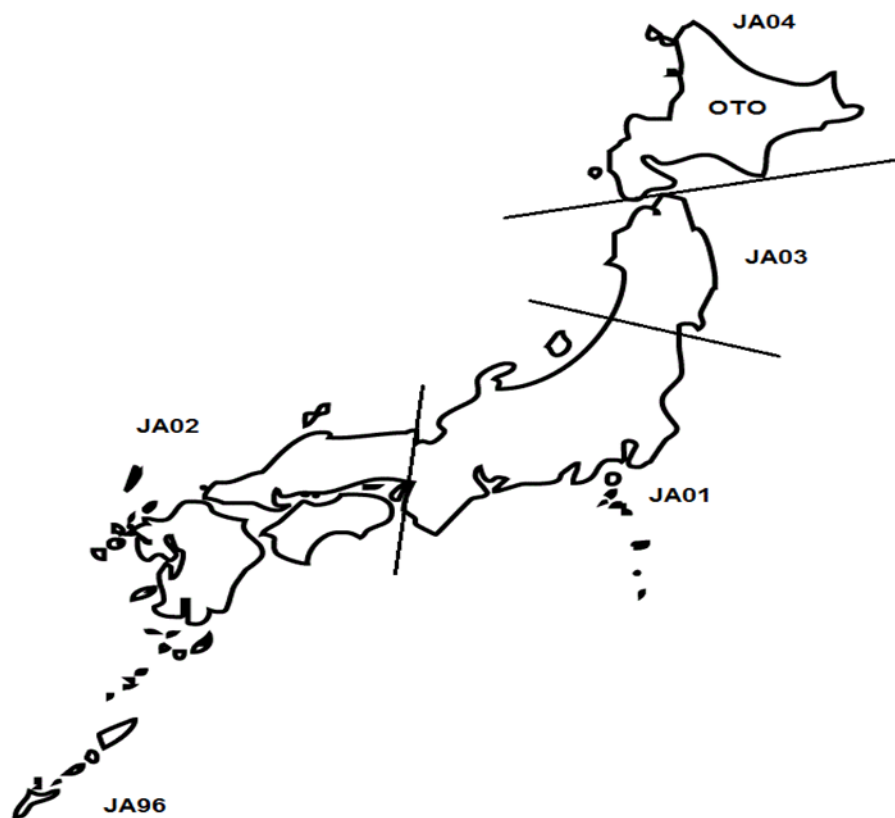

JA01 - Central		JA02 - South		JA03 - North	JA04 - OTO	JA96
Aichi	Nara	Ehime	Nagasaki	Akita	Hokkaido	Okinawa
Atsugi	Niigata	Fukuoka	Oita	Aomori		
Camp Zama	Osaka	Hyogo	Okayama	Iwate		
Chiba	Saitama	Iwakuni	Saga	Misawa		
Fukushima	Shiga	Kagawa	Sasebo	Miyagi		
Gifu	Shizuoka	Kagoshima	Shimane	Yamagata		
Gunma	Tochigi	Kochi	Tokushima			
Ibaraki	Tokyo	Kumamoto	Tottori			
Ishikawa	Toyama	Miyazaki	Yamaguchi			
Kanagawa	Wakayama					
Mie	Yokohama					
Nagano	Yokosuka					

CONUS RATE AREAS

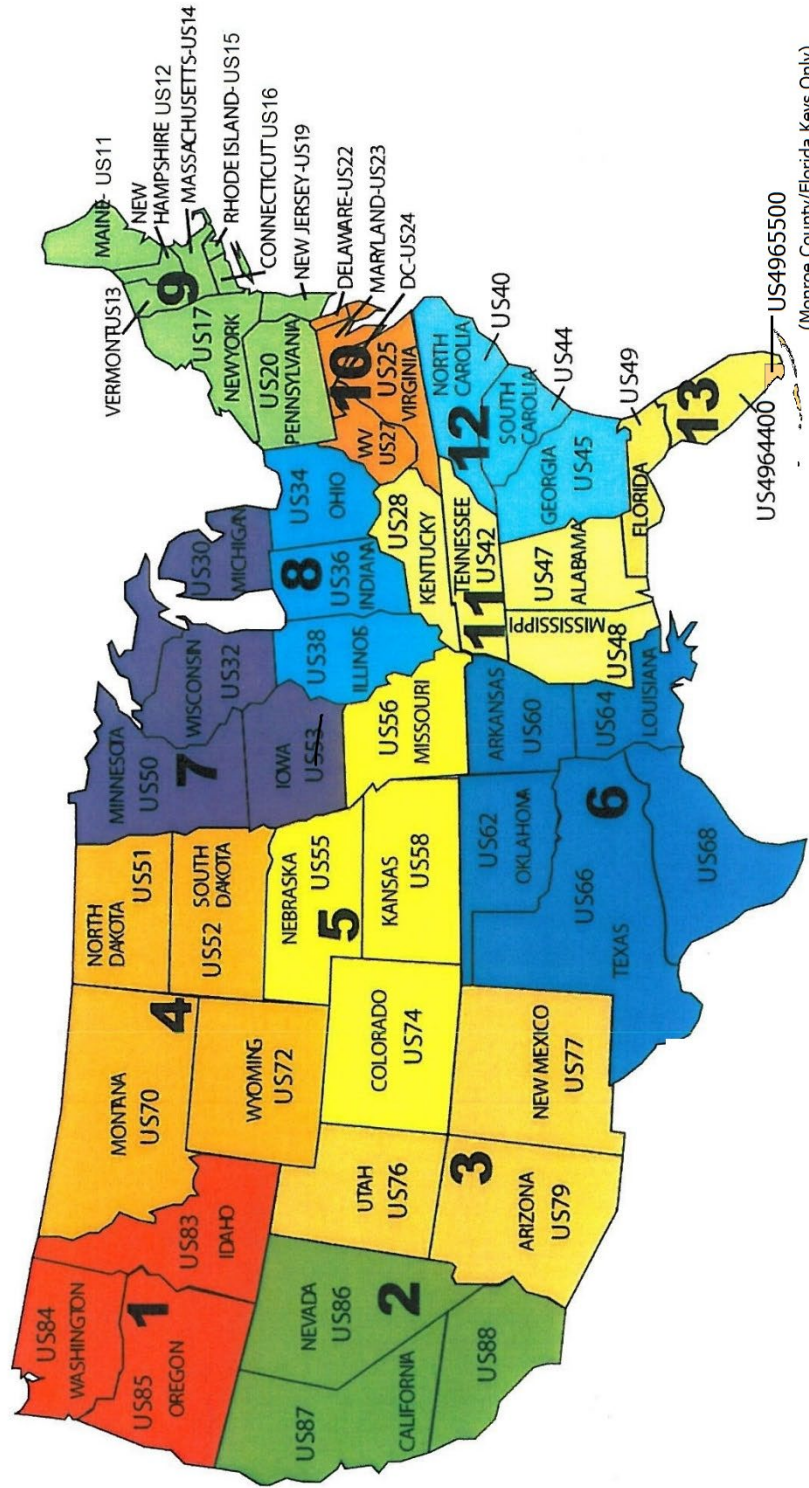

Chapter 14 - Aerial and Surface Ports

Purpose

The water and aerial ports designated for movement of COS 4, T, and J shipments are identified in this chapter.

Item 1400 - 1402 Reserved for Future Use

Item 1403 - Alternate Ports

1. When the designated port is changed during a rate cycle, the origin PPSO will certify the use of alternate ports, either water or aerial. Certification will contain the original port, revised port, and increase/decrease in mileage.
2. If the shipment is directed to a port other than that shown on the TCMD, a government representative at the port will provide the TSP a certificate/manifest showing the water/aerial port used, indicating where the shipment was received from or returned to the custody of the TSP. These certificates/manifests must accompany the original BL and other documentation to support billing in accordance with Chapter 5 of this Tender.

Item 1404 - 1406 Reserved for Future Use

Item 1407 - Code J Port Designation

1. Code J shipments will be routed via the aerial ports listed below. Refer to Item 529 for further guidance.
2. Routings may vary in accordance with AMC Channel Listing.

THE FOLLOWING DESIGNATES THE NORMAL MILITARY AIR TERMINALS UTILIZED IN SERVICING SHIPMENTS MOVING UNDER CODE J BETWEEN ALL STATES AND OVERSEAS AREAS			
BETWEEN			
	AS11**		
	AS21**		
	GQ**	BE*	
	JA01**	GE	
	JA02**	IT (except Naples)	
	JA03**	NL*	BA
	JA96**	PO01	IT10
	KS**	TU	IT (Naples only)
STATE	US89**	UK	SP
AND			
ALL	SUU	DOV	NGU

* Shipments between the Netherlands/Belgium and CONUS transit Ramstein. TSPs are responsible for movement to/from Ramstein to Netherlands and Belgium.

** All shipments to/from the Pacific will be delivered to Travis AFB, CA (SUU).

LEGEND:

DOV - Dover AFB, DE
NGU - NAS, Norfolk, VA

SUU - Travis AFB, CA
TCM - McChord AFB, WA

Item 1408 - Overseas AMC Terminals for Code J Shipments

COUNTRY	AMC TERMINAL	TERMINAL CODE
AUSTRALIA:		
Canberra (AS11)	Richmond	RCM
Alice Springs (AS21)	Alice Springs	ASP
Azores	Lajes Field	LGS
Bahrain	Bahrain	BAH
Belgium	Ramstein	RMS
Germany	Ramstein	RMS
Guam	Anderson AFB	UAM
Hawaii	Hickam AFB	HIK
ITALY:		
Aviano (IT)	Aviano AB	AVB
Leghorn (IT)	Aviano AB	AVB
Naples (IT)	Naples	NAP
San Vito (IT)	Brindisi	BDS
Vicenza (IT)	Aviano AB	AVB
JAPAN:		
JA01	Yokota AB	OKO
JA02	Yokota AB	OKO
JA03	Misawa AB	MSJ
JA96 (Okinawa)	Kadena AB	DNA
Korea	Osan AB	OSN
Netherlands	Ramstein	RMS
Sicily (IT10)	Sigonella	SIZ
Scotland	Mildenhall AB	MHZ
Spain	Rota	RTA
Turkey	Ankara	ESB
	Incirlik	ADA
United Kingdom	Mildenhall AB	MHZ

Item 1409 - Code T Port Designation

- Code T shipments will be routed via the aerial ports listed below. Refer to Item 529 for further guidance.
- Routings may vary in accordance with AMC Channel Listing.

THE FOLLOWING DESIGNATES THE NORMAL MILITARY AIR TERMINALS UTILIZED IN SERVICING SHIPMENTS MOVING UNDER CODE T BETWEEN ALL STATES AND OVERSEAS AREAS:			
BETWEEN			
	AS11 (1/3/4)		
	AS21 (1/3/4)		
	GQ (1/3)	BE (2)	
	JA01 (1/3)	GE	BA
	JA02 (1/3)	IT (except Naples)	GR29
	JA03 (1/3)	NL (2)	IT (Naples only)
	JA96 (1/3)	PO01	IT10
	KS (1/3)	TU	RQ
STATE	US89 (1/3)	UK	SP
AND			
ALL	SUU	DOV	NGU

Note 1: Intra-theater shipments moving between Australia and Pacific areas are routed from Australia POEs to Hickam AFB, Hawaii to final destination APOD via AMC airlift.

Note 2: Shipments between the Netherlands/Belgium and CONUS transit Ramstein. TSPs are responsible for movement to/from Ramstein to Netherlands and Belgium.

Note 3: All shipments to/from the Pacific will be delivered to Travis AFB, CA (SUU).

Note 4: TSPs are advised to contact responsible AMC terminal(s) for all compliance and technical guidance.

LEGEND:

NGU - NAS, Norfolk, VA
DOV - Dover AFB, DE

SUU - Travis AFB, CA
TCM - McChord AFB, WA

Item 1410 - Overseas AMC Terminals for Code T Shipments

COUNTRY	AMC TERMINAL	TERMINAL CODE
AUSTRALIA:		
Canberra (AS11)	Richmond	RCM
Alice Springs (AS21)	Alice Springs	ASP
Azores	Lajes Field	LGS
Bahrain	Bahrain	BAH
Belgium	Ramstein	RMS
Crete	Souda Bay	CHQ
England	Mildenhall AB	MHZ
Germany	Ramstein	RMS
Guam	Andersen AFB	UAM
Hawaii	Hickam AFB	HIK
ITALY:		
Aviano (IT)	Aviano AB	AVB
Leghorn (IT)	Aviano AB	AVB
Naples (IT)	Naples	NAP
San Vito (IT)	Brindisi	BDS
Vicenza (IT)	Aviano AB	AVB
	Olbiz (via Naples)	OLB
JAPAN:		
JA01	Yokota AB	OKO
JA02	Yokota AB	OKO
JA03	Misawa AB	MSJ
JA96 (Okinawa)	Kadena AB	DNA
Korea	Osan AB	OSN
Netherlands	Ramstein	RMS
Scotland	Mildenhall AB	MHZ
Sicily (IT10)	Sigonella	SIZ
Spain	Rota	RTA
Turkey	Ankara	ESB
	Incirlik	ADA
United Kingdom	Mildenhall AB	MHZ

Item 1411 - 1412 Reserved for Future Use**Item 1413 - Code 4 Ports of Embarkation and Debarkation**

Water ports designated for the movement of Code 4 between CONUS and OCONUS rate areas include but are not limited to:

CONUS PORTS**OCONUS PORTS**

Baltimore	New York	Alaska	Hawaii	Okinawa
Charleston	Norfolk	Australia	Ireland	Panama
Houston	Oakland	Belgium	Italy	Portugal
Jacksonville	San Francisco	Crete	Japan	Puerto Rico
Long Beach	Savannah	England	Korea	Saudi Arabia
Los Angeles	Seattle	Germany	Netherlands	Scotland
Miami	Wilmington	Greece	New Zealand	Spain
New Orleans		Guam	Norway	Turkey

Chapter 15 - Rate Areas and SPLC Codes

Purpose

This chapter provides rate areas and SPLC Codes for CONUS and International Rate Areas.

Item 1500 - Rate Areas & SPLC Codes

These codes are used for identifying rate areas used in the INTERNATIONAL program and must be used for identification of rate areas when filing rates. Incorrect codes will result in rejection of rates.

Item 1501 - CONUS Rate Areas, SPLC Codes & Abbreviations

Reference Map of CONUS Rate Areas in Item 1303.

RATE AREA	CONUS SPLC CODE
Alabama	US47
Arizona	US79
Arkansas	US60
California-North	US87
California-South	US88
Colorado	US74
Connecticut	US16
Delaware	US22
District Of Columbia	US24
Florida-North	US49
Florida-South	US4964400
Florida Keys	US4965500
Georgia	US45
Idaho	US83
Illinois	US38
Indiana	US36
Iowa	US53
Kansas	US58
Kentucky	US28
Louisiana	US64
Maine	US11
Maryland	US23
Massachusetts	US14
Michigan	US30
Minnesota	US50
Mississippi	US48
Missouri	US56

RATE AREA	CONUS SPLC CODE
Montana	US70
Nebraska	US55
Nevada	US86
New Hampshire	US12
New Jersey	US19
New Mexico	US77
New York	US17
North Carolina	US40
North Dakota	US51
Ohio	US34
Oklahoma	US62
Oregon	US85
Pennsylvania	US20
Rhode Island	US15
South Carolina	US44
South Dakota	US52
Tennessee	US42
Texas-North	US66
Texas-South	US68
Utah	US76
Vermont	US13
Virginia	US25
Washington	US84
West Virginia	US27
Wisconsin	US32
Wyoming	US72

Item 1502 - Overseas Rate Areas & SPLC Codes

RATE AREA	SPLC CODE
Alaska (Zone)	
I	US8101000
II	US8190100
III	US8050500
IV	US8142800
V	US8030400
Argentina	AR
Australia	AS11
Australia - Alice Springs	AS21
Azores	PO01
Bahrain	BA
Belgium	BE
Bolivia	BL
Brazil	BR
Canada - Ontario	CA10
Canada - Quebec	CA20
Canada - Manitoba	CA30
Chile	CI
Colombia	CO
Costa Rica	CS
Crete	GR29
Ecuador	EC
El Salvador	ES
Germany	GE
Greece	GR
Guam	GQ
Guatemala	GT
Hawaii	US89
Honduras	HO

RATE AREA	SPLC CODE
Hungary	HU
Israel	IS
Italy	IT
Japan-Central	JA01
Japan-South	JA02
Japan-North	JA03
Jordan	JO
Korea	KS
Kuwait	KU
Netherlands	NL
Norway	NO
Okinawa	JA96
Paraguay	PA
Peru	PE
Poland	PL
Portugal	PO
Puerto Rico	RQ
Qatar	QA
Romania	RO
Saudi Arabia	SA
Sicily	IT10
Singapore	SN
Spain	SP
Turkey	TU
United Kingdom (England & Wales)	UK
Uruguay	UY
Venezuela	VE

Item 1503 - Intra-Country Move Rate Areas

1. COS 4 (iHHG) Rates will be solicited for the following Intra-country channels:
 - a. Belgium to Belgium
 - b. Germany to Germany
 - c. Italy to Italy
 - d. Netherlands to Netherlands
 - e. Spain to Spain
 - f. United Kingdom to United Kingdom

-
2. All other European Intra-country move requests for countries not listed above will be moved via the OTO program.

Chapter 16 - Historical Shipment Data and Channel Control Listing

Purpose

This chapter provides information regarding shipment data and the channel control listing for each rate cycle.

Item 1600 - Historical Shipment Data

1. Shipment data represents historical traffic data.
2. Shipment data is shown only where USTRANSCOM historical data records movement of traffic. However, shipments may be generated between all areas during this period.
3. Data can be found at <https://www.ustranscom.mil/dp3/pdfs.cfm>.

Item 1601 - Traffic Awards

1. Traffic offerings and allocation will be accomplished by the PPSOs.
2. USTRANSCOM and the military services will maintain surveillance to ensure the traffic allocation principles are followed.

Item 1602 - Channel Control

1. The channel control printout stipulates the open and closed rate fields by codes of service for each origin/destination combination for which rates may be filed.
2. TSPs should review their DoD approval and listing prior to filing rates.
3. TSPs are encouraged to file compensatory rates and only to those areas where they desire to serve.
4. The Channel Control Listing (CCL) of solicited rates is available during the rate filing period in DPS.

Item 1603 - Web Links

1. For access to Rate Cycle Channel Control Listings, refer to the Standard and Special Solicitation Channel Control Lists located at <https://www.ustranscom.mil/dp3/pdfs.cfm>.

Attachments

CERTIFICATION OF INDEPENDENT PRICING

Please review and agree to the following terms and conditions:

1. For the purpose of inducing the United States to accept these tendered rates of fares, the undersigned declares, with the understanding that a false statement is a violation of law subject to criminal and civil penalties, that the following is true:
 - a) Except as described in paragraph 2, below, the rates or fares in tenders submitted in response to United States Transportation Command (USTRANSCOM) rate solicitations have been arrived at independently and, there has been no communication, agreement, understanding, collusion, or any other action in respect to these rates or fares, with any carrier, competitor, or agent thereof.
 - b) Except as described in paragraph 2 below, the rates or fares or other related information submitted have not and will not be disclosed directly or indirectly to any other carrier, competitor, or agent thereof prior to public disclosure of such rates by a government agency with which they have been filed.
 - c) No action has been or will be taken, and no agreement or understanding has been made or will be made, with any other carrier, competitor, or agent thereof to:
 - (1) submit or not to submit rates or fares; or
 - (2) change, cancel, or withdraw rates or fares; or
 - (3) file the same or prearranged rates or fares; or
 - (4) restrict competition for United States Government traffic by any means or device.
2. It is understood that this certification does not prohibit discussions concerning this tender between a freight forwarder and its underlying carriers, between a carrier or freight forwarder and its agents providing underlying transportation service or equipment, or between or among interline carriers jointly participating in rate tenders. It is also understood that this certification does not prohibit discussions concerning these tenders between commonly owned companies (carriers or freight forwarders) if the common ownership has been previously disclosed in writing to the USTRANSCOM. Further, this certification does not prohibit discussions concerning rate tenders between a carrier and its rate filing agents or consultants, provided that the carrier has instructed in writing such agents or consultants to preserve the confidentiality of such discussions.
3. The undersigned further certifies that I am responsible for determining the rates or fares being offered in rate tenders: that I have been authorized, in writing, to sign this certificate on behalf of the carrier; that I have not participated and will not participate in any action contrary to subparagraphs 1. a) through 1. c) above; and, that I have no knowledge that any other person has taken such action: OR
 - a) I am an authorized agent for the carrier; that I have not personally participated, and will not participate, in any action contrary to subparagraphs 1. a) through 1. c) above; that as an agent I have been authorized, in writing, to certify, and do hereby certify that the following principals have not participated in any action contrary to subparagraphs 1. a) through 1. c) above:
 - b) This certification applies to any medium used for the offering of the rates or fares, to include paper and any type of electronic submission.

Transportation Service Provider Name

SCAC

Printed TSP President/CEO Name

Signature of TSP President/CEO

Date

Figure 1. Certification of Independent Pricing

NONDISCLOSURE AGREEMENT FOR USTRANSCOM DP3 PROGRAM

This Agreement is a standard agreement designed for use by any Transportation Service Provider (TSP) or TSP Representative who is filing rates to be utilized in the United States Transportation Command (USTRANSCOM) Defense Personal Property Program (DP3). Its use is designed to protect non-public information from disclosure, identify potential conflicts of interest, and prevent violations of federal statutes or regulations. The restrictions contained in this agreement also serve TSPs by promoting compliant behavior that keeps TSPs eligible to compete in DP3 and compliant with Federal anti-trust laws. In addition to the potential impact on future business opportunities, failure to abide by this agreement could result in administrative, civil, or criminal penalties specified by statute or regulation.

1. I, _____ currently an employee of _____, hereby agree to the terms and conditions set forth below.
2. I understand that I may have access to confidential business information, TSP bid or proposal information (as defined by FAR 3.104-1), source selection information (as defined by AR 2.101), TSP rates, and discounts through use of the DP3. I fully understand that such information is sensitive and must be protected in accordance with 41 US Code Section 423 and FAR SubPart 3.1.
3. In the course of shipping under DP3 contract or some other contract or sub-contract for USTRANSCOM, I agree to:
 - a) Use only for Government purpose any and all confidential business information, TSP bid or proposal information, TSP rates and discounts to which I am given access. I agree not to disclose "non-public information" by any means (in whole or in part, alone or in combination with other information, directly, indirectly, or derivatively) to any person except to a US Government official or system with a need to know or to a non-Government person (including, but not limited to, a person in my company, affiliated companies, sub-contractors, etc.) who has a need to know related to the immediate contract/order, has executed a valid form of this non-disclosure agreement, and receives prior clearance by USTRANSCOM. All distribution of the agreement/documents will be controlled with the concurrence of USTRANSCOM.
 - b) "Non-public information," as used herein includes trade secrets; confidential or proprietary business information (as defined for Government employees in 18 USC 1905); bidding information (future bids, acquisition or bidding strategies, TSP bids or proposal information); sensitive information protected from release under the Freedom of Information Act (privileged material, etc.); and information that has not been released to the general public and has not been authorized for such release (as defined for Government employees in 5 CFR 2635.703).
 - c) Not use such information for any non-Governmental purposes, including, but not limited to, the preparation of bids or proposals, or the development or execution of other business or commercial ventures.
 - d) Store the information in such a manner as to prevent inadvertent disclosure or releases to individuals who have not been authorized access to it.
4. I understand that I must never make an unauthorized disclosure or use of confidential business information, TSP bid or proposal information, sensitive information on TSP rates or discounts unless:
 - a) USTRANSCOM determines that such information is not subject to protection from release.

Figure 2. Nondisclosure Agreement

5. I agree that I shall not seek access to “non-public information” beyond what is required for the performance of the services I am contracted to perform. I agree that when I seek access to such information, attend meetings, or communicate with other parties about such information, I will identify myself as a contractor performing rate filing services. Should I become aware of any improper or unintentional release or disclosure of “non-public information,” I will immediately report it to USTRANSCOM in writing. I agree that I will return all forms (including copies or reproduction of original documents) of any “non-public information” provided to me by the Government for use in performing my duties to the control of the Government when my duties no longer require this information.
6. Because the Government expects compliance with all statues and regulations from contractors performing work in DP3, I agree to advise USTRANSCOM of any actual or potential personal conflicts of interest I may have related to any work I perform in DP3 in representing a TSP to the government.
7. **Personal conflicts of interest include:**
 - a) Any matter in which I or my spouse, minor child, or household member has a financial interest.
 - b) **A financial interest:** Is any interest in, or affiliation with, a prime contractor, subcontractor to a prime contractor, any offeror(s), or any prospective subcontractor to any offeror for the program, contract, or other matter for which I am performing a support task under this contract.
 - c) The financial interest can take the form of any ownership interest (including but not limited to: stock; ownership of bonds; vested or unvested retirement benefits; a loan or other financial arrangement that is other than an arm’s-length transaction; employment, or an arrangement concerning prospective employment including negotiations therefore; or any non-arm’s length loan, any gift from or other non-arm’s length financial arrangement with any person who is directly communicating with the government on behalf of the prime contractor, subcontractor, or any prospective subcontractor or offeror).
 - d) **With respect to conflict of interest:** If any potential conflicts of interest, real or otherwise, do present themselves, then I shall immediately disclose the pertinent information to USTRANSCOM.

By signing below, I certify that I have read and understand the terms of this Non-Disclosure Agreement and Agreement to Disclose Potential Conflicts of Interest, and voluntarily agree to be bound by its terms.

Transportation Service Provider Name

SCAC

Printed TSP President/CEO Name

Signature of TSP President/CEO

Date

Printed Automated Data Processing (ADP)
Agent/Rate Filing Representative Name

Signature of Printed ADP Agent/Rate
Filing Representative

Date

Figure 2. Nondisclosure Agreement (Cont’d)